





PRICE
LIST
02 2021



consultation guidelines

61

I	RUOTE IN POLIURETANO TERMOPLASTICO (85 SHORE A), NUCLEO IN POLIAMMIDE 6	D	RÄDER AUS THERMOPLASTISCHEM POLYURETHAN (85 SHORE A), POLYAMID 6 FELGE
GB	THERMOPLASTIC POLYURETHANE WHEELS (85 SHORE A), POLYAMIDE 6 CENTRE	E	RUEDAS DE POLIURETANO TERMOPLASTICO (85 SHORE A), NUCLEO DE POLIAMIDA 6
F	ROUES EN POLYURETHANE THERMOPLASTIQUE (85 SHORE A), CORPS EN POLYAMIDE 6	RU	КОЛЕСА ИЗ ТЕРМОПЛАСТИЧНОГО ПОЛИУРЕТАНА (85 ШОР А) ОСНОВАНИЕ ИЗ ПОЛИАМИДА 6

61																				
	COD.	4 km/h	Euro	12	300	COD.	4 km/h	Euro	12	124	COD.	4 km/h	Euro	6	124	COD.	4 km/h	Euro	12	124
80x30	612201	85	6.90	12	300	614701	85	13.10	12	124	614801	85	10.56	6	124	614901	85	19.50	12	124
100x30	612202	120	7.92	12	300	614702	120	14.12	12	100	614802	120	11.58	6	100	614902	120	20.52	12	100
125x35	612203	180	11.52	6	180	614703	180	20.42	12	70	614803	180	16.32	6	70	614903	180	26.82	12	70

1 Descrizione prodotto
Product description
Description du produit
Produktbeschreibung
Descripción del producto
Описание продукта

2 Tipo mozzo
Hub type
Type de moyeu
Nabentyp
Tipo de buje
Тип ступицы

3 Tipo supporto
Castor type
Type de monture
Gehäusetyp
Tipo de soporte
Тип ступицы

4 Diametro ruota x larghezza ruota
Wheel diameter x wheel width
Diamètre roue x largeur roue
Raddurchmesser x Radbreite
Diametro rueda x ancho bandaje
Диаметр колеса и ширина колеса

5 Codice articolo
Item code
Code référence
Artikelcode
Código del artículo
Код изделия

6 Portata
Load capacity
Capacité de charge
Tragkraft
Capacidad de carga
Грузоподъемность

7 Prezzo - Euro
Price - Euro
Prix - Euro
Preis - Euro
Precio - Euro
Цена - Евро

8 Quantità minima Imballo Industriale
Minimum quantity for industrial packing
Quantités minimales emballage industriel
Mindestmenge für Industrieverpackung
Cantidad mínima embalaje industrial
Минимальное количество в промышленной упаковке

9 Numero di pezzi in confezioni standard
Number of pieces for standard packing
Quantité par emballage standard
Menge für Standard-Verpackung
Cantidad para embalaje standard
Количество изделий в стандартной упаковке

10 Articoli disponibili in Gamma Base
Items available with the Essential Range Service
Références disponibles en Gamme Base
Artikel lieferbar mit dem Grundsoriment-Dienst
Artículos disponible con el servicio Gama Base
Изделия, представленные в Базовой Гамме



GAMMA BASE - ESSENTIAL RANGE

SERVIZIO GAMMA BASE

Gli articoli in listino che si differenziano per il colore rosso vengono approntati in 48 ore e spediti con trasporto urgente con un addebito per il servizio veloce in Italia o in aggiunta ad un ordine in corso in Europa. Il servizio è valido per ordini in quantità non superiore ad un massimo garantito.

ESSENTIAL RANGE SERVICE

The red highlighted items in the price list can be prepared within 48 hours and shipped with an extra charge for the urgent service for Italy or added to an existing order for Europe. Service is valid for orders in quantities not exceeding the maximum granted indicated.

SERVICE GAMME DE BASE

Les références se démarquant dans le listing avec la couleur rouge peuvent être commandés en de quantités non supérieures à un maximum déterminé.

Elles sont disponibles en 48 heures et expédiées avec transport urgent aux frais du client pour le service rapide en Italie, ou ajoutées à une commande en cours pour l'Europe.

GRUNDSORTIMENTDIENST

Diese Produkte sind in der Preisliste mit der roten Farbe gekennzeichnet. Sie können nur in bestimmten garantierten Mindestmengen bestellt werden, werden in 48 Stunden produziert und mit einem kostenpflichtigen Expressdienst (Italien) oder ergänzend zu einer bestehenden Bestellung (Europaweit) geliefert.

SERVICIO GAMA BASE

Los artículos de tarifa con símbolo de color rojo se pueden pedir hasta una cantidad máxima garantizada y se preparan dentro de las 48 horas de la recepción del pedido.

En Italia el material se envía por medio de un transporte urgente y el servicio tiene un cargo adicional.

Para destinos a otros Países europeos, el servicio puede usarse en agregación a pedidos pendientes.

УСЛУГА ПРЕДСТАВЛЯЕТСЯ ДЛЯ ОСНОВНОЙ ГАММЫ ПРОДУКЦИИ.

Продукты, которые отмечены в прайс-листе красным цветом, можно заказать в количествах, не превышающих обозначенного допустимого максимума. Продукты должны быть изготовлены в течение 48 часов и отправлены срочным транспортом с дополнительным счетом за срочную доставку по Италии или в дополнение к заказу, находящемуся в стадии исполнения, по Европе.

BARCODES

ETICHETTE CON CODICE A BARRE EAN 13

Su richiesta del cliente, i prodotti possono essere approntati con applicata etichetta con codice a barre EAN 13.

EAN 13 BARCODES LABELS

Upon request, the items can be provided with EAN 13 barcodes labels applied.

ÉTIQUETTES AVEC CODES BARRES EAN 13

À la demande du client, les produits peuvent être livrés avec étiquettes contenant le code EAN 13.

ETIKETTEN MIT EAN 13 STRICHCODES

Auf Kundenanfrage können die Produkte mit einem Etikett mit EAN 13 Strichcodes versehen werden.

CODIGO DE BARRAS EAN 13

Sobre pedido están disponibles los códigos de barras EAN 13 para todos los artículos de esta tarifa.

ШТРИХ-КОД ЭТИКЕТКИ EAN 13

По запросу клиента, продукты могут быть помечены наклеенной этикеткой со штрих-кодом EAN 13.



INDUSTRIAL PACKAGING SERVICE

IMBALLO INDUSTRIALE

I prodotti ordinati in imballo industriale secondo quantità minime definite per articolo sono consegnati sfusi in cartoon pallet a perdere.

Usufruento di questa modalità di confezionamento si ottiene uno sconto extra del 10%.

Le quantità minime definite sono indicate nel listino con simbolo 

INDUSTRIAL PACKAGING

The items ordered with Industrial Packaging Service according to the minimum quantities specified for each article are delivered loose in carton pallets.

This service makes it possible to have a further 10% discount.

The minimum quantities defined for Industrial Packaging service on each item are indicated in the price list by 

EMBALLAGE INDUSTRIEL

Les références commandées à travers le service Emballage Industriel, en respectant les quantités minimales définies pour chaque article, sont livrées vrac dans des cartons palettes.

Cette modalité d'emballage permet au client qui en bénéficie d'obtenir une remise supplémentaire de 10%.

Les quantités minimales définies pour ce service sont indiquées dans le listing par le symbole 

INDUSTRIEVERPACKUNG

Die Produkte und deren Menge, die in Industrieverpackung zu senden sind, werden lose in Einwegkartonpaletten geliefert.

Gemäß dieser Lieferbedingungen kann man einen zusätzlichen 10% Rabatt erhalten.

Die Menge der Industrieverpackung sind mit  gekennzeichnet.

SERVICIO EMBALAJE INDUSTRIAL

Los artículos pedidos con el servicio Embalaje Industrial respetando las cantidades mínimas indicadas, son embalados sueltos en paletas de cartón; con esta modalidad de pedido hay un descuento extra del 10%.

Las cantidades mínimas son indicadas en la tarifa con el símbolo 

ПРОМЫШЛЕННАЯ УПАКОВКА

Продукты, заказанные в промышленной упаковке, согласно необходимому минимуму для каждого артикула поставляются россыпью в картонных одноразовых поддонах. Выбирая этот вид упаковки Вы получаете дополнительную скидку в 10%.

Минимальное допустимое количество для индустриальной упаковки отображаются в прайс листе символом 



STANDARD PACKAGING SERVICE

CONFEZIONI STANDARD

Gli articoli ordinati in confezioni standard sono posizionati su un vassoio in cartone ed avvolti in termoretraibile trasparente. La confezione standard è antipolvere, sovrapponibile, ottimizza lo spazio e, mantenendo il prodotto visibile, agevola il prelievo degli articoli dai magazzini.

L'imballo è in materiale riciclabile al 100%.

Le quantità definite per confezione standard sono indicate nel listino con il simbolo ■■

STANDARD PACKAGING

The items ordered in Standard Packaging are placed on cardboard trays and shrink-wrapped. The standard packaging protects items from dust, while keeping the products visible; this makes it easy to withdraw the articles from warehouse.

The packaging is made from 100% recyclable materials.

The quantities defined for the Standard Packaging service on each item are indicated in the price list by ■■

EMBALLAGES STANDARDS

Les articles commandés à travers le service Emballages Standards sont placés dans sur un plateau en carton et enveloppés avec un emballage thermo-rétractable transparent.

L'emballage standard protège de la poussière, est superposable, optimise l'espace tout en maintenant le produit visible, et facilite le retrait des articles des magasins.

En outre, l'emballage est en matériaux recyclables à 100%.

Les quantités définies pour le service Emballages Standards sont indiquées dans le listing par le symbole ■■

STANDARDVERPACKUNG

Die Produkte in der Standardverpackung sind auf eine Kartonplatte gestellt und in einem durchsichtigen Schrumpferpackung eingewickelt.

Die Standardverpackung ist staubbindend und platzsparend, kann man verschiedene davon übereinander legen und dank seines durchsichtigen Aussehen, vereinfacht sie die Abnahme der Produkten vom Lager.

Die Verpackung ist 100% aus Wertstoff.

Die Menge der Standardverpackung sind mit ■■ gekennzeichnet.

EMBALAJE STANDARD

Los artículos pedidos en embalaje standard se empajan en envases de carton con film transparente. La confección standard protege contra el polvo, se puede sobreponer una encima de la otra, mejoran la organización del stock y agilizan la recogida del material, por ser visible.

El embalaje es reciclable al 100%.











































Las cantidades definidas por cada confección standard son indicadas en la tarifa con el símbolo ■■

СТАНДАРТНАЯ УПАКОВКА

































Продукты, заказанные в стандартных упаковках, размещаются на картонном лотке и завернуты в термоусадочную прозрачную пленку. Стандартная упаковка является пыленепроницаемой, она накладывается сверху, оптимизирует пространство и обеспечивая постоянную видимость продукта, облегчает забор продукции со склада. Упаковка представляет собой 100% перерабатываемый материал.

































Минимальное допустимое количество для стандартной упаковки отображаются в прайс листе символом ■■



	mm	daN	Cat. 01/2021	Pr. L. 02/2021		mm	daN	Cat. 01/2021	Pr. L. 02/2021
22		 80-200  4 km/h 65-225	50	9	37		 40-125  3 km/h 30-80	330	20
23		 80-200  4 km/h 65-230	56	12	38		 40-125  3 km/h 30-80	336	22
32		 40-60  3 km/h 30-90	320	14	39		 50-75  20-40	358	23
33		 30-50  10-30	350	16	51		 80-250  Static 30-120	340	24
34		 35-100  10-40	352	17	52		 80-250  4 km/h 65-300	62	25
35		 45-65  20-40	356	18	53		 80-280  4 km/h 65-390	70	29
36		 30-75  3 km/h 30-140	326	19	53_{AS}		 80-200  4 km/h 65-230	362	33

product index

		mm					mm		
		daN	Cat. 01/2021	Pr. L. 02/2021			daN	Cat. 01/2021	Pr. L. 02/2021
60		 80-250 4 km/h 120-750	92	34	62^{ESD}		 100-200 4 km/h 240-560	366	60
61		 80-200 4 km/h 75-300	102	43	63^{AC}		 100-250 4 km/h 250-1500	172	62
62^{BS}		 80-200 4 km/h 160-700	138	48	63^{GH}		 80-300 4 km/h 280-2300	178	64
62^{AL}		 100-250 4 km/h 300-800	144	43	64		 100-250 4 km/h 250-1500	188	68
62^{ER}		 100-250 4 km/h 200-800	152	49	65^{AL}		 80-200 4 km/h 220-850	200	74
62^{GH}		 200-400 4 km/h 800-1700	160	52	65^{GH}		 150-300 4 km/h 400-2200	208	77
62^{NY}		 100-200 4 km/h 230-500	166	55	65^{HT}		 100-250 4 km/h 350-1000	214	79

		mm					mm		
		daN	Cat. 01/2021	Pr. L. 02/2021			daN	Cat. 01/2021	Pr. L. 02/2021
65_{ER}		 125-250 4 km/h 450-1000	220	81	69		 100-200 4 km/h 500-1400	244	106
65_{ESD}		 80-200 4 km/h 170-680	372	83	71		 80-200 4 km/h 70-225	78	108
66		 80-250 4 km/h 150-1000	226	85	72_{AL}		 100-250 4 km/h 180-500	250	114
67		 80-200 4 km/h 150-500	268	91	72_{GH}		 125-300 4 km/h 180-500	258	117
68		 65-250 4 km/h 120-1200	110	93	72_{GS}		 100 4 km/h 80	280	120
68_P		 100-200 4 km/h 350-1500	236	101	73		 100-200 4 km/h 150-450	122	121
68_{FV}		 100-250 4 km/h 250-350	276	105	73_{AE}		 100-200 4 km/h 150-350	130	127

product index

		mm					mm		
		daN	Cat. 01/2021	Pr. L. 02/2021			daN	Cat. 01/2021	Pr. L. 02/2021
74		 80-85 4 km/h 400-1000	286	129	82		 260 4 km/h 150	86	138
75		 35-85 4 km/h 100-800	290	130	82_{AF}		 260 Static 70	88	139
75_{HS}		 85 4 km/h 480-890	296	132	STEMS, COUNTERPLATES			370	140
76		 40-82 4 km/h 700-1200	300	134	DIRECTIONAL LOCKS			372	142
77		 82-85 4 km/h 450-600	302	135	FOOTGUARDS			376	142
78		 82 4 km/h 450-750	304	136					
79		 80-85 4 km/h 450-650	306	137					

I RUOTE IN GOMMA GRIGIA ANTITRACCIA,
NUCLEO IN POLIPROPILENE

D RÄDER AUS GRAUEM NICHTKREIDENDEM GUMMI,
POLYPROPYLENFELGE





GB GREY NON-MARKING RUBBER WHEELS,
POLYPROPYLENE CENTRE





E RUEDAS DE GOMA GRIS ANTI- HUELLA,
NUCLEO DE POLIPROPILENO

F ROUES EN CAOUTCHOUC GRIS NON-TACHANT,
CORPS EN POLYPROPYLENE

RU КОЛЁСА ИЗ СЕРОЙ РЕЗИНЫ, НЕ ОСТАВЛЯЮЩЕЙ
СЛЕДОВ С ОСНОВАНИЕМ ИЗ ПОЛИПРОПИЛЕНА

22

22																				
	COD.	4 km/h	Euro	12	300	COD.	4 km/h	Euro	12	124	COD.	4 km/h	Euro	6	124	COD.	4 km/h	Euro	12	124
80x25 lm 39	222101	65	2.59	12	300	224401	65	9.00	12	124	225701	65	6.38	6	124	225201	65	15.63	12	124
100x30 lm 44	222102	80	3.16	12	300	224402	80	9.57	12	100	225702	80	6.94	6	100	225202	80	16.20	12	100
125x37.5	221103	110	5.11	6	180	224403	110	14.32	12	70	225703	110	10.08	6	70	225203	110	20.95	12	70
140x37.5	221104	120	6.77	6	180	224404	120	15.98	12	70	225704	120	11.74	6	70	225204	120	22.60	8	70
150x40	221111	130	8.07	6	120	224411	130	17.28	12	70	225711	130	13.04	6	70	225211	130	23.91	8	70
160x40	221110	150	9.89	4	120	224410	150	25.98	4	30	225710	150	20.35	4	30	225210	150	36.54	4	30
180x45	221105	180	14.36	4	50	224405	180	31.43	4	30	225705	180	25.33	4	30	225205	180	41.99	4	30
200x50	221106	225	17.09	4	50	224406	225	34.17	2	20	225706	225	28.06	2	20	225206	225	44.72	2	20

22																				
	COD.	4 km/h	Euro	12	300	COD.	4 km/h	Euro	12	124	COD.	4 km/h	Euro	6	124	COD.	4 km/h	Euro	12	124
80x25	227701	65	9.00	12	124	225601	65	15.63	12	124	224801	65	25.98	12	62	226101	65	15.25	6	62
100x30	227702	80	9.57	12	100	225602	80	16.20	12	100	224802	80	26.55	12	50	226102	80	15.81	6	50
125x37.5	227703	110	14.32	6	70	225603	110	20.95	6	70	224803	110	32.80	12	36	226103	110	20.65	6	36
140x37.5	227704	120	15.98	6	70	225604	120	22.60	6	70	224804	120	34.46	12	36	226104	120	22.30	6	36
150x40	227711	130	17.28	6	70	225611	130	23.91	6	70	224811	130	35.76	12	36	226111	130	23.61	6	36
160x40	227710	150	25.98	4	30	225610	150	36.54	4	30	224810	150	60.61	4	16	226110	150	40.50	4	16
180x45	227705	180	31.43	4	30	225605	180	41.99	4	30	224805	180	70.43	4	16	226105	180	48.06	4	16
200x50	227706	225	34.17	2	20	225606	225	44.72	2	20	224806	225	73.16	2	10	226106	225	50.79	2	10

I RUOTE IN GOMMA GRIGIA ANTITRACCIA,
NUCLEO IN POLIPROPILENE

D RÄDER AUS GRAUEM NICHTKREIDENDEM GUMMI,
POLYPROPYLENFELGE

GB GREY NON-MARKING RUBBER WHEELS,
POLYPROPYLENE CENTRE

E RUEDAS DE GOMA GRIS ANTI- HUELLA,
NUCLEO DE POLIPROPILENO

F ROUES EN CAOUTCHOUC GRIS NON-TACHANT,
CORPS EN POLYPROPYLENE

RU КОЛЁСА ИЗ СЕРОЙ РЕЗИНЫ, НЕ ОСТАВЛЯЮЩЕЙ
СЛЕДОВ С ОСНОВАНИЕМ ИЗ ПОЛИПРОПИЛЕНА

22

22	INOX					INOX					INOX				
	COD.	4 km/h	Euro	■	■	COD.	4 km/h	Euro	■	■	COD.	4 km/h	Euro	■	■
80x25	225401	65	38.37	12	62	227801	65	25.98	12	62	225501	65	38.37	12	62
100x30	225402	80	38.94	12	50	227802	80	26.55	12	50	225502	80	38.94	12	50
125x37.5	225403	110	45.19	12	36	227803	110	32.80	6	36	225503	110	45.19	6	36
140x37.5	225404	120	46.84	8	36	227804	120	34.46	6	36	225504	120	46.84	6	36
150x40	225411	130	48.15	8	36	227811	130	35.76	6	36	225511	130	48.15	6	36
160x40	225410	150	79.07	4	16	227810	150	60.61	4	16	225510	150	79.07	4	16
180x45	225405	180	88.90	4	16	227805	180	70.43	4	16	225505	180	88.90	4	16
200x50	225406	225	91.63	2	10	227806	225	73.16	2	10	225506	225	91.63	2	10

22						NL					NL					NL				
	COD.	4 km/h	Euro	■	■	COD.	4 km/h	Euro	■	■	COD.	4 km/h	Euro	■	■	COD.	4 km/h	Euro	■	■
80x25 Im 39	224101	65	3.16	12	300	224601	65	9.57	12	124	225901	65	6.94	6	124	225221	65	16.20	12	124
100x30 Im 44	224102	80	3.73	12	300	224602	80	10.14	12	100	225902	80	7.51	6	100	225222	80	16.77	12	100
125x37.5	223103	110	5.79	6	180	224603	110	15.00	12	70	225903	110	10.75	6	70	225223	110	21.62	12	70
140x37.5	223104	120	7.44	6	180	224604	120	16.65	12	70	225904	120	12.41	6	70	225224	120	23.28	8	70
150x40	223111	130	8.75	6	120	224611	130	17.96	12	70	225911	130	13.71	6	70	225231	130	25.72	8	70
160x40	223110	150	11.71	4	120	224610	150	27.79	4	30	225910	150	22.16	4	30	225230	150	38.35	4	30
200x50	223106	225	18.90	4	50	224606	225	35.98	2	20	225906	225	29.87	2	20	225226	225	46.53	2	20

I RUOTE IN GOMMA GRIGIA ANTITRACCIA,
NUCLEO IN POLIPROPILENE

D RÄDER AUS GRAUEM NICHTKREIDENDEM GUMMI,
POLYPROPYLENFELGE

GB GREY NON-MARKING RUBBER WHEELS,
POLYPROPYLENE CENTRE

E RUEDAS DE GOMA GRIS ANTI- HUELLA,
NUCLEO DE POLIPROPILENO

F ROUES EN CAOUTCHOUC GRIS NON-TACHANT,
CORPS EN POLYPROPYLENE

RU КОЛЕСА ИЗ СЕРОЙ РЕЗИНЫ, НЕ ОСТАВЛЯЮЩЕЙ
СЛЕДОВ С ОСНОВАНИЕМ ИЗ ПОЛИПРОПИЛЕНА

22

22



	COD.	4 km/h	Euro	■	■	COD.	4 km/h	Euro	■	■						
80x25	227901	65	9.57	12	124	225621	65	16.20	12	124						
100x30	227902	80	10.14	12	100	225622	80	16.77	12	100						
125x37.5	227903	110	15.00	6	70	225623	110	21.62	6	70						
140x37.5	227904	120	16.65	6	70	225624	120	23.28	6	70						
150x40	227911	130	17.96	6	70	225631	130	25.72	6	70						
160x40	227910	150	27.79	4	30	225630	150	38.35	4	30						
200x50	227906	225	35.98	2	20	225626	225	46.53	2	20						

	COD.	Euro														
80x25	100027	2.04														
100x30	100027	2.04														
125x37.5	100010	2.33														
140x37.5	100010	2.33														
150x40	100028	2.35														
200x50	100007	2.89														

Per ordinare ruote e supporti montati con parafili, indicare il suffisso PF dopo il codice del complessivo ruota e supporto
 To order castors fitted with threadguards, please add "PF" to the complete unit code
 Pour commander les roues at roulettes avec pare-fils montées on doit indiquer après le code de la référence le suffixe "PF"
 Falls ein Fadenschutz gewünscht wird, bitte der Artikel-Nr. die Abkürzung "PF" hinzufügen
 Para solicitar un artículo con placa anti-hilos se necesita la sigla PF despues del código del artículo de la rueda con soporte
 Чтобы заказать колеса и опоры с нитезащитным устройством, необходимо указать аббревиатуру PF после кода узла колесо + опора.

Accessori (contropiastre, codoli, bloccaggi direzionali, parapiedi) : pag 142-144
 Accessories (counter-plates, stems, directional locks, footguards): page 142-144
 Accessoires (contre-platines, tiges, blocages directionnels, pare-pieds): page 142-144
 Zubehör (Gegenplatten, Zapfen, Richtungsfeststeller, Fußschutz): Seite 142-144
 Accesorios (contraplacas, espigas, posicionadores direccionales, guardapié): pág 142-144
 ДОПОЛНИТЕЛЬНЫЕ ПРИНАДЛЕЖНОСТИ (Панели, стержни, Фиксатор направления движения, Защиты для ног): стр. 142-144

I RUOTE IN GOMMA GRIGIA ANTITRACCIA, DISCHI DI LAMIERA

D RÄDER AUS GRAUEM NICHTKREIDENDEM GUMMI, STAHLBLECHFELGE

GB GREY NON-MARKING RUBBER WHEELS, PRESSED STEEL DISCS

E RUEDAS DE GOMA GRIS ANTI-HUELLA, LLANTAS DE CHAPA











F ROUES EN CAOUTCHOUC GRIS NON-TACHANT, DISQUES EN TOLE

RU КОЛЕСА ИЗ СЕРОЙ РЕЗИНЫ, НЕ ОСТАВЛЯЮЩЕЙ СЛЕДОВ С ДИСКАМИ ИЗ МЕТАЛЛИЧЕСКОГО ЛИСТА

23









23



																
																
	COD.	4 km/h	Euro	■ ■ ■ ■	COD.	4 km/h	Euro	■ ■ ■ ■	COD.	4 km/h	Euro	■ ■ ■ ■	COD.	4 km/h	Euro	■ ■ ■ ■
80x25 lm 39	231121	65	3.34	12 300	234401	65	9.76	12 124	235701	65	7.13	6 124	235201	65	16.38	12 124
100x30 lm 44	231122	80	4.27	12 300	234402	80	10.69	12 100	235702	80	8.06	6 100	235202	80	17.32	12 100
125x37.5	231103	130	6.05	6 180	234403	130	15.27	12 70	235703	130	11.02	6 70	235203	130	21.89	12 70
140x37.5	231104	150	7.90	6 180	234404	150	17.11	12 70	235704	150	12.87	6 70	235204	150	23.73	8 70
150x40	231111	170	9.00	6 120	234411	170	18.22	12 70	235711	170	13.97	6 70	235211	170	24.84	8 70
160x40	231110	180	11.02	4 120	234410	180	27.11	4 30	235710	180	21.48	4 30	235210	180	37.66	4 30
200x50	231106	230	18.33	4 50	234406	230	35.41	2 20	235706	230	29.30	2 20	235206	230	45.96	2 20











23



										
										
	COD.	4 km/h	Euro	■ ■ ■ ■	COD.	4 km/h	Euro	■ ■ ■ ■		
80x25	237701	65	9.76	12 124	235601	65	16.38	12 124		
100x30	237702	80	10.69	12 100	235602	80	17.32	12 100		
125x37.5	237703	130	15.27	6 70	235603	130	21.89	6 70		
140x37.5	237704	150	17.11	6 70	235604	150	23.73	6 70		
150x40	237711	170	18.22	6 70	235611	170	24.84	6 70		
160x40	237710	180	27.11	4 30	235610	180	37.66	4 30		
200x50	237706	230	35.41	2 20	235606	230	45.96	2 20		

23



																
																
	COD.	4 km/h	Euro	■ ■ ■ ■	COD.	4 km/h	Euro	■ ■ ■ ■	COD.	4 km/h	Euro	■ ■ ■ ■	COD.	4 km/h	Euro	■ ■ ■ ■
80x25 lm 39	233121	65	3.91	12 300	234601	65	10.33	12 124	235901	65	7.70	6 124	235221	65	16.95	12 124
100x30 lm 44	233122	80	4.84	12 300	234602	80	11.26	12 100	235902	80	8.63	6 100	235222	80	17.88	12 100
125x37.5	233103	130	6.73	6 180	234603	130	15.94	12 70	235903	130	11.70	6 70	235223	130	22.56	12 70
140x37.5	233104	150	8.57	6 180	234604	150	17.78	12 70	235904	150	13.54	6 70	235224	150	24.41	8 70
150x40	233111	170	9.68	6 120	234611	170	18.89	12 70	235911	170	14.65	6 70	235231	170	25.51	8 70
160x40	233110	180	12.83	4 120	234610	180	28.92	4 30	235910	180	23.29	4 30	235230	180	39.47	4 30
200x50	233106	230	20.14	4 50	234606	230	37.22	2 20	235906	230	31.11	2 20	235226	230	47.78	2 20

I RUOTE IN GOMMA GRIGIA ANTITRACCIA, DISCHI DI LAMIERA

D RÄDER AUS GRAUEM NICHTKREIDENDEM GUMMI, STAHLBLECHFELGE

GB GREY NON-MARKING RUBBER WHEELS, PRESSED STEEL DISCS

E RUEDAS DE GOMA GRIS ANTI- HUELLA, LLANTAS DE CHAPA

F ROUES EN CAOUTCHOUC GRIS NON-TACHANT, DISQUES EN TOLE

RU КОЛЕСА ИЗ СЕРОЙ РЕЗИНЫ, НЕ ОСТАВЛЯЮЩЕЙ СЛЕДОВ С ДИСКАМИ ИЗ МЕТАЛЛИЧЕСКОГО ЛИСТА

23



	COD.	4 km/h	Euro	■	■	COD.	4 km/h	Euro	■	■						
80x25	237901	65	10.33	12	124	235621	65	16.95	12	124						
100x30	237902	80	11.26	12	100	235622	80	17.88	12	100						
125x37.5	237903	130	15.94	6	70	235623	130	22.56	6	70						
140x37.5	237904	150	17.78	6	70	235624	150	24.41	6	70						
150x40	237911	170	18.89	6	70	235631	170	25.51	6	70						
160x40	237910	180	28.92	4	30	235630	180	39.47	4	30						
200x50	237906	230	37.22	2	20	235626	230	47.78	2	20						

	COD.	Euro														
80x25	100010	2.33														
100x30	100009	2.35														
125x37.5	100012	2.48														
140x37.5	100014	2.57														
150x40	100014	2.57														
160x40	100015	2.71														
180x45	100016	3.44														
200x50	100017	5.87														

Per ordinare ruote e supporti montati con parafili, indicare il suffisso PF dopo il codice del complessivo ruota e supporto
 To order castors fitted with threadguards, please add "PF" to the complete unit code
 Pour commander les roues at roulettes avec pare-fils montés on doit indiquer après le code de la référence le suffixe "PF"
 Falls ein Fadenschutz gewünscht wird, bitte der Artikel-Nr. die Abkürzung "PF" hinzufügen
 Para solicitar un artículo con placa anti-hilos se necesita la sigla PF despues del código del artículo de la rueda con soporte
 Чтобы заказать колеса и опоры с нитезащитным устройством, необходимо указать аббревиатуру PF после кода узла колесо + опора.

Accessori (contropiastre, codoli, bloccaggi direzionali, parapiedi) : pag 142-144
 Accessories (counter-plates, stems, directional locks, footguards): page 142-144
 Accessoires (contre-platines, tiges, blocages directionnels, pare-pieds): page 142-144
 Zubehör (Gegenplatten, Zapfen, Richtungsfeststeller, Fußschutz): Seite 142-144
 Accesorios (contraplacas, espigas, posicionadores direccionales, guardapié): pág 142-144
 ДОПОЛНИТЕЛЬНЫЕ ПРИНАДЛЕЖНОСТИ (Панели, стержни, Фиксатор направления движения, Защиты для ног): стр. 142-144

I RUOTE PER COLLETTIVITA'
IN POLIAMMIDE 6

D APPARATENROLLEN
AUS POLYAMID 6



GB POLYAMIDE 6
INSTITUTIONAL WHEELS









E RUEDAS PARA COMUNIDADES
DE POLIAMIDA 6









F ROULETTES POUR COLLECTIVITES
EN POLYAMIDE 6









RU КОЛЕСА ДЛЯ ОБЩЕСТВЕННЫХ
УЧРЕЖДЕНИЙ ИЗ ПОЛИАМИДА 6

32

32																				
																				
	COD. 3 km/h Euro ■ ■ ■ ■ ■ ■	COD. 3 km/h Euro ■ ■ ■ ■ ■ ■	COD. 3 km/h Euro ■ ■ ■ ■ ■ ■	COD. 3 km/h Euro ■ ■ ■ ■ ■ ■																
40x17	321102	30	0.62	24	500	324001	30	7.81	12	100	326001	30	7.98	12	100	324101	30	3.37	24	150
50x17	321104	40	0.73	24	500	324002	40	8.04	12	100	326002	40	8.21	12	100	324102	40	3.49	24	150
50x22	321105	50	0.99	24	500															
60x22	321106	60	1.16	24	500	324003	60	11.35	12	100	326003	60	11.52	12	100	324103	60	5.14	24	150

32																				
																				
	COD. 3 km/h Euro ■ ■ ■ ■ ■ ■	COD. 3 km/h Euro ■ ■ ■ ■ ■ ■	COD. 3 km/h Euro ■ ■ ■ ■ ■ ■	COD. 3 km/h Euro ■ ■ ■ ■ ■ ■																
40x17	325101	30	2.29	24	150	326101	30	3.46	24	150										
50x17	325102	40	2.40	24	150	326102	40	3.57	24	150	324302	90	8.06	12	150	328202	90	12.10	12	150
60x22	325103	60	3.74	24	150	326103	60	5.23	24	150										

32																				
																				
	COD. 3 km/h Euro ■ ■ ■ ■ ■ ■	COD. 3 km/h Euro ■ ■ ■ ■ ■ ■	COD. 3 km/h Euro ■ ■ ■ ■ ■ ■	COD. 3 km/h Euro ■ ■ ■ ■ ■ ■																
50x(17+17)	323202	90	7.99	12	150	327202	90	12.03	12	150	326202	90	8.17	12	150	329202	90	12.20	12	150

32																				
																				
	COD. 3 km/h Euro ■ ■ ■ ■ ■ ■	COD. 3 km/h Euro ■ ■ ■ ■ ■ ■	COD. 3 km/h Euro ■ ■ ■ ■ ■ ■	COD. 3 km/h Euro ■ ■ ■ ■ ■ ■																
50x30	324402	80	7.52	12	150	328302	80	11.56	12	150	323302	80	7.45	12	150	327302	80	11.49	12	150

32

I RUOTE PER COLLETTIVITA'
IN POLIAMMIDE 6

D APPARATENROLLEN
AUS POLYAMID 6

GB POLYAMIDE 6
INSTITUTIONAL WHEELS

E RUEDAS PARA COMUNIDADES
DE POLIAMIDA 6

F ROULETTES POUR COLLECTIVITES
EN POLYAMIDE 6

RU КОЛЕСА ДЛЯ ОБЩЕСТВЕННЫХ
УЧРЕЖДЕНИЙ ИЗ ПОЛИАМИДА 6

32



COD.



3 km/h

Euro



COD.



3 km/h

Euro



50x30

326302

80

7.63

12

150

329302

80

11.66

12

150

I RUOTE PER MOBILIO SFERICHE
IN GOMMA

D SPHÄRISCHE MÖBELROLLEN
AUS GUMMI





GB RUBBER BALL
FURNITURE WHEELS



E RUEDAS DOMESTICAS DE GOMA,
ESFERICAS

F ROULETTES D'AMEUBLEMENT
SPHERIQUES EN CAOUTCHOUC

RU СФЕРИЧЕСКИЕ РЕЗИНОВЫЕ
КОЛЕСА ДЛЯ МЕБЕЛИ

33

33																				
	COD.		■	Euro	■ ■ ■ ■ ■ ■	COD.		■	Euro	■ ■ ■ ■ ■ ■	COD.		■	Euro	■ ■ ■ ■ ■ ■	COD.		■	Euro	■ ■ ■ ■ ■ ■
	30	334101	10	7.29	24	150	336101	10	7.29	24	150	333101	10	7.16	24	150	334001	10	15.72	12
40	334102	20	8.01	24	150	336102	20	8.01	24	150	333102	20	7.89	24	150	334002	20	17.17	12	100
50	334103	30	10.00	24	150	336103	30	10.00	24	150	333103	30	9.87	24	150	334003	30	21.15	12	100

33																				
	COD.		■	Euro	■ ■ ■ ■ ■ ■	COD.		■	Euro	■ ■ ■ ■ ■ ■	COD.		■	Euro	■ ■ ■ ■ ■ ■	COD.		■	Euro	■ ■ ■ ■ ■ ■
	30	336001	10	15.72	12	100	333001	10	15.46	12	100									
40	336002	20	17.17	12	100	333002	20	16.91	12	100										
50	336003	30	21.15	12	100	333003	30	20.89	12	100										

I RUOTE GEMELLATE PER MOBILIO
IN POLIAMMIDE 6 E IN POLIPROPILENE

D DOPPELTE MÖBELROLLEN
AUS POLYAMID 6 ODER POLYPROPYLEN

GB PAIRED FURNITURE POLYAMIDE 6
AND POLYPROPYLENE WHEELS

E RUEDAS DOMESTICAS PAREADAS
DE POLIAMIDA 6 Y DE POLIPROPILENO

F ROUES D'AMEUBLEMENT JUMEELES
EN POLYAMIDE 6 ET EN POLYPROPYLENE

RU КОЛЁСА ИЗ СЕРОЙ РЕЗИНЫ, НЕ ОСТАВЛЯЮЩЕЙ
СЛЕДОВ С ОСНОВАНИЕМ ИЗ ПОЛИПРОПИЛЕНА

34

34	POLYAMIDE 6 WHEELS					POLYAMIDE 6 WHEELS					POLYAMIDE 6 WHEELS				
	COD.		Euro			COD.		Euro			COD.		Euro		
35x39	344100	10	1.80	24	150	346200	10	1.80	24	150	340000	10	4.84	12	100
50x59	344101	30	2.32	24	150	346201	30	2.32	24	150	340001	30	5.88	12	100

34	TRANSPARENT POLYPROPYLENE WHEELS					TRANSPARENT POLYPROPYLENE WHEELS					TRANSPARENT BLUE POLYPROPYLENE WHEELS					TRANSPARENT BLUE POLYPROPYLENE WHEELS				
	COD.		Euro			COD.		Euro			COD.		Euro			COD.		Euro		
50x54	347002	20	1.58	24	150	347102	20	1.58	24	150	347202	20	1.58	24	150	347302	20	1.58	24	150

34	POLYAMIDE 6 WHEELS					POLYAMIDE 6 WHEELS					POLYAMIDE 6 WHEELS					POLYAMIDE 6 WHEELS				
	COD.		Euro			COD.		Euro			COD.		Euro			COD.		Euro		
60x42	347403	30	4.71	12	150	342103	30	6.99	12	150	342203	30	4.71	12	150	342303	30	6.99	12	150
75x48	347404	30	5.15	12	124	342104	30	7.43	12	124	342204	30	5.15	12	124	342304	30	7.43	12	124
100x57	347405	40	23.87	12	100	342105	40	28.32	12	100	342205	40	23.87	12	100	342305	40	28.32	12	100

35

I RUOTE PER MOBILIO
SEMISFERICHE IN GOMMA

D HALBSPHÄRISCHE MÖBELROLLEN
AUS GUMMI

GB RUBBER FURNITURE
TYRED BALL CASTORS

















E RUEDAS DOMESTICAS DE GOMA
SEMI-ESFERICAS

F ROULETTES D'AMEUBLEMENT
SEMI-SPHERIQUES

RU ПОЛУСФЕРИЧЕСКИЕ РЕЗИНОВЫЕ
КОЛЕСА ДЛЯ МЕБЕЛИ

35



	 					 					   CON				
	COD.		Euro			COD.		Euro			COD.	 4 km/h	Euro		
45 DX	354101	20	4.52	24	150	356101	20	4.52	24	150	350001	20	10.29	12	100
45 SX	354201	20	4.52	24	150	356201	20	4.52	24	150					
55 DX	354102	30	5.31	24	150	356102	30	5.31	24	150	350002	30	11.86	12	100
55 SX	354202	30	5.31	24	150	356202	30	5.31	24	150					
65 DX	354103	40	7.19	24	150	356103	40	7.19	24	150					
65 SX	354203	40	7.19	24	150	356203	40	7.19	24	150					

DX = destra, right, droite, rechts, derecha, правое/право
SX = sinistra, left, gauche, links, izquierda, левое/ево

Le ruote della serie 35 sono fornite solo accoppiate, una destra e una sinistra.

Series 35 wheels can only be supplied as pair, one right and one left.

Les roues de la série 35 sont uniquement fournies par deux, une droite et une gauche.

Die Räder der Serie 35 werden nur paarweise, d.h. je ein linkes und ein rechtes Rad, geliefert.

Las ruedas de la serie 35 son suministradas solamente por pares (una derecha y una izquierda).

Колеса серии 35 поставляются только парами (правое + левое).

I RUOTE PER COLLETTIVITA' IN POLIURETANO TERMOPLASTICO, NUCLEO IN POLIAMMIDE 6

D APPARATENROLLEN AUS THERMOPLASTISCHEM POLYURETHAN, FELGE AUS POLYAMID 6

GB INSTITUTIONAL THERMOPLASTIC POLYURETHANE WHEELS, POLYAMIDE 6 CENTRE

E RUEDAS PARA COLECTIVIDAD DE POLIURETANO TERMOPLASTICO, NUCLEO DE POLIAMIDA 6

F ROUES POUR COLLECTIVITÉ EN POLYURETHANE TERMOPLASTIQUE, CORPS EN POLYAMIDE 6

RU КОЛЕСА ИЗ ТЕРМОПЛАСТИЧНОГО ПОЛИУРЕТАНА ОСНОВАНИЕ ИЗ ПОЛИАМИДА 6

36

36



COD.	3 km/h	Euro	■ ■		COD.	3 km/h	Euro	■ ■		COD.	3 km/h	Euro	■ ■		COD.	3 km/h	Euro	■ ■		
			■ ■	■ ■				■ ■	■ ■				■ ■	■ ■						
30x18	361100	30	1.78	24	500	364300	30	4.23	24	150	365100	30	3.30	24	150					
40x18	361101	40	1.95	24	500	364301	40	4.40	24	150	365101	40	3.47	24	150	368101	40	7.92	24	150
50x18	361102	55	2.21	24	500	364302	55	5.60	12	150	365102	55	4.67	12	150	368102	55	9.64	12	150
60x25	361103	70	3.90	24	500	364303	70	9.25	12	150	365103	70	6.98	12	150	368103	70	13.29	12	150
75x24	361104	90	5.00	24	300	364304	90	10.51	12	150	365104	90	7.82	12	150	368104	90	14.54	12	150

36



COD.	3 km/h	Euro	■ ■		COD.	3 km/h	Euro	■ ■		COD.	3 km/h	Euro	■ ■		COD.	3 km/h	Euro	■ ■		
			■ ■	■ ■				■ ■	■ ■				■ ■	■ ■						
30x18	363100	30	4.16	24	150					366300	30	4.44	24	150						
40x18	363101	40	4.33	24	150	367101	40	7.85	24	150	366301	40	4.61	24	150	369101	40	8.07	24	150
50x18	363102	55	5.53	12	150	367102	55	9.56	12	150	366302	55	5.75	12	150	369102	55	9.79	12	150
60x25	363103	70	9.18	12	150	367103	70	13.22	12	150	366303	70	9.41	12	150	369103	70	13.44	12	150
75x24	363104	90	10.43	12	150	367104	90	14.47	12	150	366314	90	10.66	12	150	369114	90	14.70	12	150

36



COD.	3 km/h	Euro	■ ■		COD.	3 km/h	Euro	■ ■		COD.	3 km/h	Euro	■ ■		COD.	3 km/h	Euro	■ ■		
			■ ■	■ ■				■ ■	■ ■				■ ■	■ ■						
40x18	364001	40	9.94	8	100	366001	40	10.25	8	100										
50x18	364002	55	12.34	8	100	366002	55	12.65	8	100	364402	140	11.02	12	150	368202	140	15.06	12	150
60x25	364003	70	19.64	8	100	366003	70	19.95	8	100										

36



COD.	3 km/h	Euro	■ ■		COD.	3 km/h	Euro	■ ■		COD.	3 km/h	Euro	■ ■		COD.	3 km/h	Euro	■ ■		
			■ ■	■ ■				■ ■	■ ■				■ ■	■ ■						
50x(18+18)	363202	140	10.95	12	150	367202	140	14.99	12	150	366402	140	11.13	12	150	369202	140	15.16	12	150

I RUOTE PER COLLETTIVITA' IN GOMMA GRIGIA, NUCLEO IN POLIAMMIDE CON PARAFILI

D GRAUGUMMI-APPARATENROLLEN, POLYAMIDKERN MIT FADENSCHUTZ





GB GREY RUBBER INSTITUTIONAL WHEELS, POLYAMIDE CENTRE WITH THREADGUARDS





E RUEDAS PARA COMUNIDADES DE GOMA GRIS, NUCLEO DE POLIAMIDA CON PARA-HILOS



F ROUES POUR COLLECTIVITÉ EN CAOUTCHOUC GRIS, CORPS EN POLYAMIDE 6 AVEC PARE-FILS

RU КОЛЕСА ДЛЯ ОБЩЕСТВЕННЫХ УЧРЕЖДЕНИЙ ИЗ СЕРОЙ РЕЗИНЫ, С ЗАЩИТОЙ ОТ ЗАСОРЕНИЯ

37

37																				
	COD.	3 km/h	Euro	■	■	COD.	3 km/h	Euro	■	■	COD.	3 km/h	Euro	■	■	COD.	3 km/h	Euro	■	■
40x18	371100	30	2.17	12	500	374100	30	4.68	12	150	375100	30	4.26	12	150	378100	30	8.20	12	150
50x18	371101	35	2.32	12	500	374101	35	5.70	12	150	375101	35	5.19	12	150	378101	35	9.74	12	150
60x24	371102	50	3.63	12	500	374102	50	8.98	12	150	375102	50	6.71	12	150	378102	50	13.02	12	150
75x24	371203	55	4.27	12	300	374303	55	9.78	12	124	375303	55	7.40	12	124	378303	55	13.82	12	124
80x24	371103	55	4.96	12	300	374103	55	10.46	12	124	375103	55	8.08	12	124	378103	55	14.50	12	124
100x24	371104	60	6.58	12	300	374104	55	12.09	12	100	375104	55	9.71	12	100	378104	55	16.13	12	100
125x30	371105	80	9.46	12	180	374105	80	20.56	12	70	375105	80	14.35	12	70	378105	80	25.32	12	70

37																				
	COD.	3 km/h	Euro	■	■	COD.	3 km/h	Euro	■	■	COD.	3 km/h	Euro	■	■	COD.	3 km/h	Euro	■	■
40x18	373100	30	4.61	12	150	377100	30	8.12	12	150	376100	30	4.83	12	150	379100	30	8.35	12	150
50x18	373101	35	5.63	12	150	377101	35	9.67	12	150	376101	35	5.86	12	150	379101	35	9.89	12	150
60x24	373102	50	8.91	12	150	377102	50	12.95	12	150	376102	50	9.14	12	150	379102	50	13.18	12	150
75x24	373303	55	9.71	12	124	377303	55	13.74	12	124	376303	55	9.94	12	124	379303	55	13.97	12	124
80x24	373103	55	10.39	12	124	377103	55	14.43	12	124	376103	55	10.62	12	124	379103	55	14.66	12	124
100x24	373104	55	12.02	12	100	377104	55	16.05	12	100	376104	55	12.24	12	100	379104	55	16.28	12	100
125x30	373105	80	20.48	12	70	377105	80	25.24	12	70	376105	80	20.71	12	70	379105	80	25.47	12	70

37																				
	COD.	3 km/h	Euro	■	■	COD.	3 km/h	Euro	■	■										
50x18	374001	35	12.54	8	100	376001	35	12.85	8	100										
60x24	374002	50	19.11	8	100	376002	50	19.42	8	100										

I RUOTE PER COLLETTIVITA' IN GOMMA GRIGIA,
NUCLEO IN POLIAMMIDE CON PARAFILI

D GRAUGUMMI-APPARATENROLLEN,
POLYAMIDKERN MIT FADENSCHUTZ

GB GREY RUBBER INSTITUTIONAL WHEELS,
POLYAMIDE CENTRE WITH THREADGUARDS

E RUEDAS PARA COMUNIDADES DE GOMA GRIS,
NUCLEO DE POLIAMIDA CON PARA-HILOS





















F ROUES POUR COLLECTIVITÉ EN CAOUTCHOUC GRIS,
CORPS EN POLYAMIDE 6 AVEC PARE-FILS

RU КОЛЕСА ДЛЯ ОБЩЕСТВЕННЫХ УЧРЕЖДЕНИЙ ИЗ
СЕРОЙ РЕЗИНЫ, С ЗАЩИТОЙ ОТ ЗАСОРЕНИЯ

37

37



	 					 					 					 				
	COD.	 3 km/h	Euro			COD.	 3 km/h	Euro			COD.	 3 km/h	Euro			COD.	 3 km/h	Euro		
50x(18+18)	374201	60	10.85	12	150	378201	60	14.88	12	150	376201	60	10.95	12	150	379201	60	14.99	12	150
75x(24+24)	374203	80	17.14	12	124	378203	80	21.18	12	124	376203	80	17.24	12	124	379203	80	21.28	12	124

I RUOTE PER COLLETTIVITA' IN GOMMA
TERMOPLASTICA GRIGIA ANTITRACCIA,
NUCLEO IN POLIPROPILENE

D APPARATENROLLEN AUS GRAUEM
THERMOPLASTISCHEM SPURLOSEM
GUMMI, POLYPROPYLENFELGE

GB INSTITUTIONAL GREY NON-MARKING
THERMOPLASTIC RUBBER WHEELS,
POLYPROPYLENE CENTRE

E RUEDAS PARA COLECTIVIDAD DE GOMA
TERMOPLASTICA GRIS ANTI- HUELLA,
NUCLEO DE POLIPROPILENO

F ROUES POUR COLLECTIVITÉ EN CAOUTCHOUC
THERMOPLASTIQUE GRIS NON-TACHANT,
CORPS EN POLYPROPYLENE

RU КОЛЕСА ДЛЯ ОБЩЕСТВЕННЫХ ИЗ
ТЕПМОПЛАСТИЧНОЙ РЕЗИНЫ, ОСНОВАНИЕ ИЗ
ПОЛИПРОПИЛЕНА

38

38



	COD.	3 km/h	Euro	24	500	COD.	3 km/h	Euro	24	150	COD.	3 km/h	Euro	24	150	COD.	3 km/h	Euro	24	150
40x18	381100	30	1.51	24	500	384200	30	4.05	24	150	385200	30	3.89	24	150	388200	30	7.05	24	150
50x18	381101	40	1.73	24	500	384201	40	4.37	24	150	385201	40	4.11	24	150	388201	40	7.37	24	150
60x24	381102	60	1.99	24	500	384202	60	5.82	12	150	385202	60	4.47	12	150	388202	60	8.82	12	150
75x24	381203	70	2.69	12	300	384303	70	7.56	12	124	385303	70	5.80	12	124	388303	70	10.56	12	124
80x24	381103	70	2.86	24	300	384203	70	7.72	12	124	385203	70	5.96	12	124	388203	70	10.72	12	124

38



	COD.	3 km/h	Euro	24	150	COD.	3 km/h	Euro	24	150	COD.	3 km/h	Euro	24	150	COD.	3 km/h	Euro	24	150
40x18	383200	30	3.94	24	150	387200	30	6.94	24	150	386200	30	4.15	24	150	389200	30	7.15	24	150
50x18	383201	40	4.26	24	150	387201	40	7.27	24	150	386201	40	4.47	24	150	389201	40	7.47	24	150
60x24	383202	60	5.71	12	150	387202	60	8.71	12	150	386202	60	5.92	12	150	389202	60	8.92	12	150
75x24	383303	70	7.45	12	124	387303	70	10.45	12	124	386303	70	7.66	12	124	389303	70	10.66	12	124
80x24	383203	70	7.62	12	124	387203	70	10.62	12	124	386203	70	7.82	12	124	389203	70	10.83	12	124

39

I RUOTE PER MOBILIO IN POLIURETANO
TRASPARENTE, NUCLEO IN METACRILATO

D MÖBELROLLEN AUS DURCHSICHTIGEM
POLYURETHAN, METHACRYLATKERN

GB TRANSPARENT POLYURETHANE FURNITURE
WHEELS, METHACRYLATE CENTRE

E RUEDAS PARA MOBILIARIO DE POLIURETANO
TRASPARENTE, NUCLEO DE METACRILATO

F ROUES EN POLYURETHANE TRANSPARENT,
CORPS EN METHACRYLATE

RU КОЛЕСА ИЗ ПРОЗРАЧНОГО ПОЛИУРЕТАНА
С ОСНОВАНИЕМ ИЗ МЕТАКРИЛАТА

39



COD.



Euro



COD.



Euro



50x20

392002

20

6.74

12

150

392102

20

6.82

12

150

75x22

392004

40

13.97

12

124

392104

40

14.06

12

124

I RUOTE IN GOMMA TERMOPLASTICA NERA,
NUCLEO IN POLIPROPILENE

D RÄDER AUS SCHWARZEM THERMOPLASTISCHEM
GUMMI, POLYPROPYLENFELGE

























GB BLACK THERMOPLASTIC RUBBER WHEELS,
POLYPROPYLENE CENTRE























E RUEDAS DE GOMA TERMOPLASTICA NEGRA,
NUCLEO DE POLIPROPILENO

F ROUES EN CAOUTCHOUC THERMOPLASTIQUE NOIR,
CORPS EN POLYPROPYLENE

RU КОЛЁСА ИЗ ТЕРМОПЛАСТИЧНОЙ РЕЗИНЫ
ЧЁРНОГО ЦВЕТА С ОСНОВАНИЕМ ИЗ
ПОЛИПРОПИЛЕНА

51

51																						
																						
	COD.	Static	Euro	12	300	COD.	Static	Euro	12	124	COD.	Static	Euro	6	124							
80x26	511101	30	1.71	12	300	514401	30	8.12	12	124	515701	30	5.50	6	124							
100x30 F. 8	511112	35	1.86	12	300																	
100x30 F. 12	511122	35	1.86	12	300	514402	35	8.28	12	100	515702	35	5.65	6	100							
125x35	511103	50	2.54	6	180	514403	50	11.75	12	70	515703	50	7.50	6	70							
150x35	511104	90	3.31	6	120	514404	90	12.52	12	70	515704	90	8.28	6	70							
175x45	511105	100	5.64	4	50																	
200x50	511106	120	6.21	4	50																	
250x50	511108	120	10.39	2	24																	

51																						
																						
	COD.	Static	Euro	12	124	COD.	Static	Euro	12	100												
80x26	514411	30	7.21	12	124	516801	30	7.37	12	124												
100x30	514412	35	7.37	12	100	516802	35	7.52	12	100												

I RUOTE IN GOMMA STANDARD,
NUCLEO IN POLIPROPILENE

D STANDARD GUMMI-RÄDER,
POLYPROPYLENKERN

GB STANDARD RUBBER WHEELS,
POLYPROPYLENE CENTRE

E RUEDAS DE GOMA STANDARD,
NUCLEO DE POLIPROPILENO

F ROUES EN CAOUTCHOUC STANDARD,
CORPS EN POLYPROPYLENE

RU КОЛЕСА ИЗ СТАНДАРТНОЙ РЕЗИНЫ,
ОСНОВАНИЕ ИЗ ПОЛИПРОПИЛЕНА

52

52				
	COD.		Euro	
80x25	522101	65	1.71	12 300
100x30	521132	80	1.86	12 300
125x37.5	521133	110	3.09	12 180

52				
	COD.		Euro	
80x25	526101	65	5.80	12 124
100x30	526102	80	6.42	12 100
125x37.5	526103	110	8.58	12 70

52				
	COD.		Euro	
80x25 lm 39	522101	65	1.71	12 300
100x30 lm 44	522102	80	1.86	12 300
125x37.5	521103	110	3.09	6 180
140x37.5	521104	120	4.39	6 180
150x40	521111	130	5.18	6 120
160x40B	521110	150	6.48	4 120
160x40				
180x45	521105	180	8.66	4 50
200x50 F. 20	521106	225	9.08	4 50
200x50 F. 25	521206	225	9.08	4 50
250x60	521108	300	20.50	2 24

I RUOTE IN GOMMA STANDARD,
NUCLEO IN POLIPROPILENE

D STANDARD GUMMI-RÄDER,
POLYPROPYLENKERN







GB STANDARD RUBBER WHEELS,
POLYPROPYLENE CENTRE









E RUEDAS DE GOMA STANDARD,
NUCLEO DE POLIPROPILENO

F ROUES EN CAOUTCHOUC STANDARD,
CORPS EN POLYPROPYLENE

RU КОЛЕСА ИЗ СТАНДАРТНОЙ РЕЗИНЫ,
ОСНОВАНИЕ ИЗ ПОЛИПРОПИЛЕНА

52

52																				
			NL					NL					NL							
	COD.	4 km/h	Euro	■	■	COD.	4 km/h	Euro	■	■	COD.	4 km/h	Euro	■	■	COD.	4 km/h	Euro	■	■
80x25	527701	65	8.12	12	124	525601	65	14.75	12	124										
100x30	527702	80	8.28	12	100	525602	80	14.90	12	100										
125x37.5	527703	110	12.31	6	70	525603	110	18.93	6	70										
140x37.5	527704	120	13.60	6	70	525604	120	20.22	6	70										
150x40	527711	130	14.39	6	70	525611	130	21.01	6	70										
160x40	527710	150	22.56	4	30	525610	150	33.12	4	30										
180x45	527705	180	25.74	4	30	525605	180	36.30	4	30										
200x50	527706	225	26.15	2	20	525606	225	36.71	2	20	524206	225	36.71	2	20					

52																				
			INN.					INN.					NL					NL		
	COD.	4 km/h	Euro	■	■	COD.	4 km/h	Euro	■	■	COD.	4 km/h	Euro	■	■	COD.	4 km/h	Euro	■	■
100x30											529202	80	11.21	12	100	529302	80	17.83	12	100
125x37.5											529203	110	15.24	8	70	529303	110	21.86	6	70
150x40											529211	130	17.32	8	70	529311	130	23.94	8	70
160x40	525520	150	38.98	4	30	525620	150	49.54	4	30	529210	150	29.89	4	30	529310	150	40.45	4	30
200x50	525516	225	42.57	2	20	525616	225	53.13	2	20	529206	225	33.48	2	20	529306	225	44.04	2	20

I RUOTE IN GOMMA STANDARD,
NUCLEO IN POLIPROPILENE

D STANDARD GUMMI-RÄDER,
POLYPROPYLENKERN









































GB STANDARD RUBBER WHEELS,
POLYPROPYLENE CENTRE





















E RUEDAS DE GOMA STANDARD,
NUCLEO DE POLIPROPILENO

F ROUES EN CAOUTCHOUC STANDARD,
CORPS EN POLYPROPYLENE

RU КОЛЕСА ИЗ СТАНДАРТНОЙ РЕЗИНЫ,
ОСНОВАНИЕ ИЗ ПОЛИПРОПИЛЕНА

52

52																								
																								
	COD.		Euro			COD.		Euro			COD.		Euro			COD.		Euro						
80x25 Im 39	524101	65	2.28	12	300	524601	65	8.69	12	124	525901	65	6.07	6	124	525221	65	15.32	12	124				
100x30 Im 44	524102	80	2.43	12	300	524602	80	8.85	12	100	525902	80	6.22	6	100	525222	80	15.47	12	100				
125x37.5	523103	110	3.77	6	180	524603	110	12.98	12	70	525903	110	8.74	6	70	525223	110	19.60	12	70				
140x37.5	523104	120	5.06	6	180	524604	120	14.27	12	70	525904	120	10.03	6	70	525224	120	20.90	8	70				
150x40	523111	130	5.85	6	120	524611	130	15.06	12	70	525911	130	10.82	6	70	525231	130	21.68	8	70				
160x40B	523110	150	8.29	4	120	524612	150	22.08	6	30	525912	150	17.25	6	30									
160x40						524610	150	24.37	4	30	525910	150	18.74	4	30	525230	150	34.93	4	30				
180x45	523105	180	10.47	4	50	524605	180	27.55	4	30	525905	180	21.45	4	30	525225	180	38.11	4	30				
200x50 F. 20	523106	225	10.89	4	50	524606	225	27.97	2	20	525906	225	21.86	2	20	525226	225	38.52	2	20				
200x50 F. 25	523206	225	10.89	4	50																			
250x60	523108	300	22.57	2	24	524908	300	71.98	1	8	525908	300	48.66	1	8									

52																		
																		
	COD.		Euro			COD.		Euro										
80x25	527901	65	8.69	12	124	525621	65	15.32	12	124								
100x30	527902	80	8.85	12	100	525622	80	15.47	12	100								
125x37.5	527903	110	12.98	6	70	525623	110	19.60	6	70								
140x37.5	527904	120	14.27	6	70	525624	120	20.90	6	70								
150x40	527911	130	15.06	6	70	525631	130	21.68	6	70								
160x40	527910	150	24.37	4	30	525630	150	34.93	4	30								
180x45	527905	180	27.55	4	30	525625	180	38.11	4	30								
200x50	527906	225	27.97	2	20	525626	225	38.52	2	20								

I RUOTE IN GOMMA STANDARD,
NUCLEO IN POLIPROPILENE

D STANDARD GUMMI-RÄDER,
POLYPROPYLENKERN

GB STANDARD RUBBER WHEELS,
POLYPROPYLENE CENTRE

E RUEDAS DE GOMA STANDARD,
NUCLEO DE POLIPROPILENO

F ROUES EN CAOUTCHOUC STANDARD,
CORPS EN POLYPROPYLENE

RU КОЛЕСА ИЗ СТАНДАРТНОЙ РЕЗИНЫ,
ОСНОВАНИЕ ИЗ ПОЛИПРОПИЛЕНА

	● GALVANISED																			
	COD.	Euro																		
80x25	100027	2.04																		
100x30	100027	2.04																		
125x37.5	100010	2.33																		
140x37.5	100010	2.33																		
150x40	100005	2.33																		
160x40	100006	2.89																		
200x50	100007	2.89																		

Per ordinare ruote e supporti montati con parafili, indicare il suffisso PF dopo il codice del complessivo ruota e supporto

To order castors fitted with threadguards, please add "PF" to the complete unit code

Pour commander les roues et roulettes avec pare-fils montées on doit indiquer après le code de la référence le suffixe "PF"

Falls ein Fadenschutz gewünscht wird, bitte der Artikel-Nr. die Abkürzung "PF" hinzufügen

Para solicitar un artículo con placa anti-hilos se necesita la sigla PF después del código del artículo de la rueda con soporte

Чтобы заказать колеса и опоры с нитезащитным устройством, необходимо указать аббревиатуру PF после кода узла колесо + опора.

Accessori (contropiastre, codoli, bloccaggi direzionali, parapiedi) : pag 142-144

Accessories (counter-plates, stems, directional locks, footguards): page 142-144

Accessoires (contre-platines, tiges, blocages directionnels, pare-pieds): page 142-144

Zubehöre (Gegenplatten, Zapfen, Richtungsfeststeller, Fußschutz): Seite 142-144

Accesorios (contraplacas, espigas, posicionadores direccionales, guardapié): pág 142-144

ДОПОЛНИТЕЛЬНЫЕ ПРИНАДЛЕЖНОСТИ (Панели, стержни, Фиксатор направления движения, Зашиты для ног): стр. 142-144

I RUOTE IN GOMMA STANDARD,
DISCHI DI LAMIERA

D STANDARD GUMMI-RÄDER,
STAHLBLECHFELGEN





















GB STANDARD RUBBER WHEELS,
PRESSED STEEL DISCS











E RUEDAS DE GOMA STANDARD,
LLANTAS DE CHAPA





















F ROUES EN CAOUTCHOUC STANDARD,
FLANCS EN TOLE

RU КОЛЕСА ИЗ СТАНДАРТНОЙ РЕЗИНЫ,
ДИСКИ ИЗ ЛИСТОВОЙ СТАЛИ

53

53				
		 SL	 SL	 SL
	COD.  Euro  	COD.  Euro  	COD.  Euro  	COD.  Euro  
80x25	531121 65 2.46 12 300	535801 65 6.55 12 124	536001 65 5.71 6 124	536301 65 11.21 12 124
100x30	531132 80 2.98 12 300	535802 80 7.53 12 100	536002 80 6.46 6 100	536302 80 12.19 12 100
125x37.5	531133 130 4.04 12 180	535803 130 9.52 12 70	536003 130 7.86 6 70	536303 130 14.18 12 70

53				
	 SL	 SL		
	COD.  Euro  	COD.  Euro  		
80x25	536101 65 6.55 12 124	536201 65 11.21 12 124		
100x30	536102 80 7.53 12 100	536202 80 12.19 12 100		
125x37.5	536103 130 9.52 12 70	536203 130 14.18 12 70		

53				
		 NL	 NL	 NL
	COD.  Euro  	COD.  Euro  	COD.  Euro  	COD.  Euro  
80x25 lm 39	531121 65 2.46 12 300	535001 65 8.88 12 124	535701 65 6.25 6 124	535401 65 15.50 12 124
100x30 lm 44	531122 80 2.98 12 300	535002 80 9.40 12 100	535702 80 6.77 6 100	535402 80 16.02 12 100
125x37.5	531103 130 4.04 6 180	535003 130 13.25 12 70	535703 130 9.00 6 70	535403 130 19.87 12 70
140x37.5	531104 150 5.52 6 180	535004 150 14.73 12 70	535704 150 10.48 6 70	535404 150 21.35 8 70
150x40	531111 170 6.11 6 120	535011 170 15.32 8 70	535711 170 11.07 6 70	535411 170 21.94 8 70
160x40 B	531110 180 7.61 4 120	535012 180 21.39 6 30	535712 180 16.57 6 30	
160x40		535010 180 23.69 4 30	535710 180 18.06 4 30	535410 180 34.25 4 30
180x45	531105 200 10.25 4 50	535005 200 27.32 4 30	535705 200 21.22 4 30	535405 200 37.88 4 30
200x50 F. 20	531106 230 10.32 4 50	535006 230 27.40 2 20	535706 230 21.29 2 20	535406 230 37.95 2 20
200x50 F. 25	531206 230 10.32 4 50			
225x50	531107 250 20.52 4 50	535007 250 37.60 2 20	535707 250 31.50 2 20	535407 250 48.16 2 20
250x60	531108 300 23.68 2 24	534708 300 73.09 1 8	535708 300 49.76 1 8	
280x60	531109 390 31.74 2 12	534709 390 81.15 1 8	535709 390 57.83 1 8	

I RUOTE IN GOMMA STANDARD,
DISCHI DI LAMIERA

D STANDARD GUMMI-RÄDER,
STAHLBLECHFELGEN







GB STANDARD RUBBER WHEELS,
PRESSED STEEL DISCS













E RUEDAS DE GOMA STANDARD,
LLANTAS DE CHAPA

F ROUES EN CAOUTCHOUC STANDARD,
FLANCS EN TOLE

RU КОЛЕСА ИЗ СТАНДАРТНОЙ РЕЗИНЫ,
ДИСКИ ИЗ ЛИСТОВОЙ СТАЛИ

53

53																					
					NL						NL										
	COD.	4 km/h	Euro	■	■	COD.	4 km/h	Euro	■	■	COD.	4 km/h	Euro	■	■	COD.	4 km/h	Euro	■	■	
80x25	537701	65	8.88	12	124	538201	65	15.50	12	124											
100x30	537702	80	9.40	12	100	538202	80	16.02	12	100											
125x37.5	537703	130	13.25	6	70	538203	130	19.87	6	70											
140x37.5	537704	150	14.73	6	70	538204	150	21.35	6	70											
150x40	537711	170	15.32	6	70	538211	170	21.94	6	70											
160x40	537710	180	23.69	4	30	538210	180	34.25	4	30											
180x45	537705	200	27.32	4	30	538205	200	37.88	4	30											
200x50	537706	230	27.40	2	20	538206	230	37.95	2	20											

53																								
					INN.						INN.						NL						NL	
	COD.	4 km/h	Euro	■	■	COD.	4 km/h	Euro	■	■	COD.	4 km/h	Euro	■	■	COD.	4 km/h	Euro	■	■	COD.	4 km/h	Euro	■
100x30											539202	80	12.33	12	100	538802	80	18.95	12	100				
125x37.5											539203	130	16.18	6	70	538803	130	22.80	6	70				
150x40											539211	170	18.25	8	70	538811	170	24.87	8	70				
160x40	535520	180	40.11	4	30	535620	180	50.66	4	30	539210	180	31.02	4	30	538810	180	41.58	4	30				
180x45	535515	200	43.74	2	30	535615	200	54.30	4	30														
200x50	535516	230	43.81	2	20	535616	230	54.37	2	20	539206	230	34.72	2	20	538806	230	45.28	2	20				

I RUOTE IN GOMMA STANDARD,
DISCHI DI LAMIERA

D STANDARD GUMMI-RÄDER,
STAHLBLECHFELGEN

























GB STANDARD RUBBER WHEELS,
PRESSED STEEL DISCS













E RUEDAS DE GOMA STANDARD,
LLANTAS DE CHAPA

F ROUES EN CAOUTCHOUC STANDARD,
FLANCS EN TOLE

RU КОЛЕСА ИЗ СТАНДАРТНОЙ РЕЗИНЫ,
ДИСКИ ИЗ ЛИСТОВОЙ СТАЛИ

53

53																				
																				
	COD.	4 km/h	Euro	■	■	COD.	4 km/h	Euro	■	■	COD.	4 km/h	Euro	■	■	COD.	4 km/h	Euro	■	■
80x25 Im 39	533121	65	3.03	12	300	535101	65	9.45	12	124	535901	65	6.82	6	124	535421	65	16.07	12	124
100x30 Im 44	533122	80	3.55	12	300	535102	80	9.97	12	100	535902	80	7.34	6	100	535422	80	16.59	12	100
125x37.5	533103	130	4.71	6	180	535103	130	13.92	12	70	535903	130	9.68	6	70	535423	130	20.54	12	70
140x37.5	533104	150	6.19	6	180	535104	150	15.40	12	70	535904	150	11.16	6	70	535424	150	22.02	8	70
150x40	533111	170	6.78	6	120	535111	170	15.99	12	70	535911	170	11.75	6	70	535431	170	22.61	8	70
160x40 B	533110	180	9.42	4	120	535112	180	23.20	6	30	535912	180	18.38	6	30					
160x40						535110	180	25.50	4	30	535910	180	19.87	4	30	535430	180	36.06	4	30
180x45	533105	200	12.06	4	50	535105	200	29.14	4	30	535905	200	23.03	4	30	535425	200	39.69	4	30
200x50 F. 20	533106	230	12.13	4	50	535106	230	29.21	2	20	535906	230	23.10	2	20	535426	230	39.76	2	20
200x50 F. 25	533206	230	12.13	4	50															
225x50	533107	250	22.59	4	50	535107	250	39.67	2	20	535907	250	33.57	2	20	535427	250	50.23	2	20
250x60	533108	300	25.75	2	24	534908	300	75.16	1	8	535908	300	51.83	1	8					
280x60	533109	390	33.81	2	12	534909	390	83.22	1	8	535909	390	59.90	1	8					

53																				
																				
	COD.	4 km/h	Euro	■	■	COD.	4 km/h	Euro	■	■										
80x25	537901	65	9.45	12	124	538221	65	16.07	12	124										
100x30	537902	80	9.97	12	100	538222	80	16.59	12	100										
125x37.5	537903	130	13.92	6	70	538223	130	20.54	6	70										
140x37.5	537904	150	15.40	6	70	538224	150	22.02	6	70										
150x40	537911	170	15.99	6	70	538231	170	22.61	6	70										
160x40	537910	180	25.50	4	30	538230	180	36.06	4	30										
180x45	537905	200	29.14	4	30	538225	200	39.69	4	30										
200x50	537906	230	29.21	2	20	538226	230	39.76	2	20										

I RUOTE IN GOMMA STANDARD,
DISCHI DI LAMIERA



D STANDARD GUMMI-RÄDER,
STAHLBLECHFELGEN

GB STANDARD RUBBER WHEELS,
PRESSED STEEL DISCS

E RUEDAS DE GOMA STANDARD,
LLANTAS DE CHAPA

F ROUES EN CAOUTCHOUC STANDARD,
FLANCS EN TOLE

RU КОЛЕСА ИЗ СТАНДАРТНОЙ РЕЗИНЫ,
ДИСКИ ИЗ ЛИСТОВОЙ СТАЛИ

	 GALVANISED														
	COD.	Euro													
80x25	100010	2.33													
100x30	100009	2.35													
125x37.5	100012	2.48													
140x37.5	100014	2.57													
150x40	100014	2.57													
160x40	100015	2.71													
180x45	100016	3.44													
200x50	100017	5.87													

Per ordinare ruote e supporti montati con parafili, indicare il suffisso PF dopo il codice del complessivo ruota e supporto

To order castors fitted with threadguards, please add "PF" to the complete unit code

Pour commander les roues et roulettes avec pare-fils montées on doit indiquer après le code de la référence le suffixe "PF"

Falls ein Fadenschutz gewünscht wird, bitte der Artikel-Nr. die Abkürzung "PF" hinzufügen

Para solicitar un artículo con placa anti-hilos se necesita la sigla PF después del código del artículo de la rueda con soporte

Чтобы заказать колеса и опоры с нитезащитным устройством, необходимо указать аббревиатуру PF после кода узла колесо + опора.

Accessori (contropiastre, codoli, bloccaggi direzionali, parapiedi): pag 142-144

Accessories (counter-plates, stems, directional locks, footguards): page 142-144

Accessoires (contre-platines, tiges, blocages directionnels, pare-pieds): page 142-144

Zubehöre (Gegenplatten, Zapfen, Richtungsfeststeller, Fußschutz): Seite 142-144

Accesorios (contraplacas, espigas, posicionadores direccionales, guardapié): pág 142-144

ДОПОЛНИТЕЛЬНЫЕ ПРИНАДЛЕЖНОСТИ (Панели, стержни, Фиксатор направления движения, Зашиты для ног): стр. 142-144

I RUOTE IN GOMMA CONDUTTIVA,
DISCHI DI LAMIERA

D LEITFÄHIGE GUMMI-RÄDER,
STAHLBLECHFELGEN





























GB ELECTRIC CONDUCTIVE RUBBER WHEELS,
PRESSED STEEL DISCS















E RUEDAS DE GOMA CONDUCTIVA,
LLANTAS DE CHAPA

F ROUES EN CAOUTCHOUC CONDUCTEUR,
FLANCS EN TOLE

RU КОЛЕСА ИЗ АНТИСТАТИЧЕСКОЙ РЕЗИНЫ,
ДИСКИ ИЗ ЛИСТОВОЙ СТАЛИ

53AS

53AS	 					 					 					 				
				NL				NL				NL				NL				
	COD.	 4 km/h	Euro			COD.	 4 km/h	Euro			COD.	 4 km/h	Euro			COD.	 4 km/h	Euro		
80x25 Im 39	533121As	65	4.94	12	300	535101As	65	11.35	12	124	535901As	65	8.73	6	124	535421As	65	17.98	12	124
100x30 Im 44	533122As	80	6.48	12	300	535102As	80	12.90	12	100	535902As	80	10.27	6	100	535422As	80	19.52	12	100
125x37.5	533103As	130	8.95	6	180	535103As	130	18.16	12	70	535903As	130	13.92	6	70	535423As	130	24.79	12	70
150x40	533111As	170	13.44	6	120	535111As	170	22.66	12	70	535911As	170	18.41	6	70	535431As	170	29.28	8	70
160x40 B	533110As	180	16.90	4	120	535112As	180	30.69	6	30	535912As	180	25.86	6	30					
160x40						535110As	180	32.99	4	30	535910As	180	27.36	4	30	535430As	180	43.54	4	30
180x45	533105As	200	21.06	4	50	535105As	200	38.14	4	30	535905As	200	32.03	4	30	535425As	200	48.70	4	30
200x50 F. 20	533106As	230	26.92	4	50	535106As	230	44.00	2	20	535906As	230	37.89	2	20	535426As	230	54.55	2	20
200x50 F. 25	533206As	230	26.92	4	50															

53AS	 					 														
				NL				NL												
	COD.	 4 km/h	Euro			COD.	 4 km/h	Euro												
80x25	537901As	65	11.35	12	124	538221As	65	17.98	12	124										
100x30	537902As	80	12.90	12	100	538222As	80	19.52	12	100										
125x37.5	537903As	130	18.16	6	70	538223As	130	24.79	6	70										
150x40	537911As	170	22.66	6	70	538231As	170	29.28	6	70										
160x40	537910As	180	32.99	4	30	538230As	180	43.54	4	30										
180x45	537905As	200	38.14	4	30	538225As	200	48.70	4	30										
200x50	537906As	230	44.00	2	20	538226As	230	54.55	2	20										

I RUOTE IN POLIURETANO TERMOPLASTICO (55 SHORE D), NUCLEO IN POLIAMMIDE 6

D RÄDER AUS THERMOPLASTISCHEM POLYURETHAN (55 SHORE D), POLYAMID 6 FELGE





GB THERMOPLASTIC POLYURETHANE WHEELS (55 SHORE D), POLYAMIDE 6 CENTRE





E RUEDAS DE POLIURETANO TERMOPLASTICO (55 SHORE D), NUCLEO DE POLIAMIDA 6



F ROUES EN POLYURETHANE THERMOPLASTIQUE (55 SHORE D), CORPS EN POLYAMIDE 6

RU КОЛЕСА ИЗ ТЕРМОПЛАСТИЧНОГО ПОЛИУРЕТАНА (55 ШОР D) ОСНОВАНИЕ ИЗ ПОЛИАМИДА 6

60

60																				
	COD.	4 km/h	Euro	12	300	COD.	4 km/h	Euro	12	124	COD.	4 km/h	Euro	6	124	COD.	4 km/h	Euro	6	124
80x30	601101	120	3.46	12	300	604201	120	9.87	12	124	605701	120	7.25	6	124	606601	120	16.50	12	124
100x30	601102	170	4.33	12	300	604202	170	10.74	12	100	605702	170	8.11	6	100	606602	170	17.37	12	100
125x35	601103	230	7.35	6	180	604203	220	16.56	12	70	605703	220	12.32	6	70	606603	220	23.18	12	70
150x35	601105	250	7.98	6	120	604204	220	17.19	6	70	605704	220	12.95	6	70	606604	220	23.82	6	70
150x45	601104	350	10.66	6	120	604211	300	26.74	4	70	605711	300	21.11	4	70	606611	300	37.30	4	70
200x50	601106	450	20.18	4	50	604206	300	37.26	2	20	605706	300	31.15	2	20	606606	300	47.82	2	20

60																									
	COD.	4 km/h	Euro	12	124	COD.	4 km/h	Euro	12	100	COD.	4 km/h	Euro	6	100	COD.	4 km/h	Euro	6	100					
80x30	607701	120	9.87	12	124	606401	120	16.50	12	124						606102	170	13.67	12	100	606202	170	20.30	12	100
100x30	607702	170	10.74	12	100	606402	170	17.37	12	100						606103	220	19.49	6	70	606203	220	26.11	6	70
125x35	607703	220	16.56	6	70	606403	220	23.18	6	70						606104	220	20.12	6	70	606204	220	26.74	6	70
150x35	607704	220	17.19	6	70	606404	220	23.82	6	70						606111	300	34.07	4	70	606211	300	44.63	4	70
150x45	607711	300	26.74	4	70	606411	300	37.30	4	70						606106	300	44.59	2	20	606206	300	55.14	2	20
200x50	607706	300	37.26	2	20	606406	300	47.82	2	20															

60																								
	COD.	4 km/h	Euro	12	124	COD.	4 km/h	Euro	12	100														
80x30	609201	120	14.74	12	124	609301	120	21.36	12	124														
100x30	609202	130	15.61	12	100	609302	130	22.23	12	100														
125x35	609203	130	21.42	6	70	609303	130	28.05	6	70														

I RUOTE IN POLIURETANO TERMOPLASTICO (55 SHORE D), NUCLEO IN POLIAMMIDE 6

D RÄDER AUS THERMOPLASTISCHEM POLYURETHAN (55 SHORE D), POLYAMID 6 FELGE





















GB THERMOPLASTIC POLYURETHANE WHEELS (55 SHORE D), POLYAMIDE 6 CENTRE





















E RUEDAS DE POLIURETANO TERMOPLASTICO (55 SHORE D), NUCLEO DE POLIAMIDA 6





















F ROUES EN POLYURETHANE THERMOPLASTIQUE (55 SHORE D), CORPS EN POLYAMIDE 6





























RU КОЛЕСА ИЗ ТЕРМОПЛАСТИЧНОГО ПОЛИУРЕТАНА (55 ШОР D) ОСНОВАНИЕ ИЗ ПОЛИАМИДА 6

60

60															
															
	 COD.	 4 km/h	 Euro			 COD.	 4 km/h	 Euro			 COD.	 4 km/h	 Euro		
150x45	604311	350	31.21	4	70	605711	350	21.11	4	70	606811	350	43.59	4	70
200x50	604306	450	42.18	2	20	605706	450	31.15	2	20	606806	450	54.57	2	20

60															
															
	 COD.	 4 km/h	 Euro			 COD.	 4 km/h	 Euro			 COD.	 4 km/h	 Euro		
100x30	607102	170	23.37	12	100	608102	170	13.68	6	100	609002	170	29.99	12	100
125x35	607103	230	27.01	12	70	608103	230	16.89	6	70	609003	230	33.64	12	70

60															
															
	 COD.	 4 km/h	 Euro			 COD.	 4 km/h	 Euro			 COD.	 4 km/h	 Euro		
150x45	607604	350	43.23	4	70	608604	350	24.65	4	70	609004	350	59.84	4	70
200x50	607606	450	56.82	2	20	608606	450	36.40	2	20	609006	450	73.43	2	20

60																				
																				
	 COD.	 4 km/h	 Euro			 COD.	 4 km/h	 Euro			 COD.	 4 km/h	 Euro			 COD.	 4 km/h	 Euro		
80x30	604401	120	26.85	12	62	605101	120	16.11	6	62	606701	120	39.24	12	62	607901	120	26.85	12	62
100x30	604402	170	27.72	12	50	605102	170	16.98	6	50	606702	170	40.11	12	50	607902	170	27.72	12	50
125x35	604403	220	35.03	12	36	605103	220	22.88	6	36	606703	220	47.42	12	36	607903	220	35.03	6	36
150x35	604404	220	35.67	6	36	605104	220	23.52	6	36	606704	220	48.06	6	36	607904	220	35.67	6	36
150x45	604411	300	61.38	4	36	605111	300	41.27	4	36	606711	300	79.84	4	36	607911	300	61.38	4	36
200x50	604406	300	76.26	2	10	605106	300	53.88	2	10	606706	300	94.72	2	10	607906	300	76.26	2	10

I RUOTE IN POLIURETANO TERMOPLASTICO (55 SHORE D), NUCLEO IN POLIAMMIDE 6

D RÄDER AUS THERMOPLASTISCHEM POLYURETHAN (55 SHORE D), POLYAMID 6 FELGE





















GB THERMOPLASTIC POLYURETHANE WHEELS (55 SHORE D), POLYAMIDE 6 CENTRE

















E RUEDAS DE POLIURETANO TERMOPLASTICO (55 SHORE D), NUCLEO DE POLIAMIDA 6











F ROUES EN POLYURETHANE THERMOPLASTIQUE (55 SHORE D), CORPS EN POLYAMIDE 6

RU КОЛЕСА ИЗ ТЕРМОПЛАСТИЧНОГО ПОЛИУРЕТАНА (55 ШОР D) ОСНОВАНИЕ ИЗ ПОЛИАМИДА 6

60

60		INOX		INOX		INOX		INOX
	 NLX	 PX	 PX	 PX				
	COD.  4 km/h Euro  	COD.  4 km/h Euro  	COD.  4 km/h Euro  	COD.  4 km/h Euro  				
80x30	608801 120 39.24 12 62							
100x30	608802 170 40.11 12 50							
125x35	608803 220 47.42 6 36							
150x35	608804 220 48.06 6 36							
150x45	608811 300 79.84 4 36	607004 350 119.77 4 36	607114 350 60.69 4 36	607214 350 153.90 4 36				
200x50	608806 300 94.72 2 10	607006 450 132.82 2 10	607116 450 73.33 2 10	607216 450 166.95 2 10				

60				
				
	COD.  4 km/h Euro  	COD.  4 km/h Euro  	COD.  4 km/h Euro  	
125x35	609553 250 48.75 70			
150x45	609554 300 66.55 70	609654 300 57.24 70	609704 300 79.49 70	
200x50	609576 400 87.46 20	609676 400 78.14 20	609726 400 100.40 20	

60				
				
	COD.  4 km/h Euro  	COD.  4 km/h Euro  		
125x35	609563 250 52.37 70			
150x45	609564 300 70.17 70	609714 300 83.11 70		
200x50	609586 400 94.44 20	609736 400 104.02 20		

I RUOTE IN POLIURETANO TERMOPLASTICO (55 SHORE D), NUCLEO IN POLIAMMIDE 6

D RÄDER AUS THERMOPLASTISCHEM POLYURETHAN (55 SHORE D), POLYAMID 6 FELGE





GB THERMOPLASTIC POLYURETHANE WHEELS (55 SHORE D), POLYAMIDE 6 CENTRE



E RUEDAS DE POLIURETANO TERMOPLASTICO (55 SHORE D), NUCLEO DE POLIAMIDA 6



F ROUES EN POLYURETHANE THERMOPLASTIQUE (55 SHORE D), CORPS EN POLYAMIDE 6

RU КОЛЕСА ИЗ ТЕРМОПЛАСТИЧНОГО ПОЛИУРЕТАНА (55 ШОР D) ОСНОВАНИЕ ИЗ ПОЛИАМИДА 6

60

60																				
	COD.	4 km/h	Euro	■	■	COD.	4 km/h	Euro	■	■	COD.	4 km/h	Euro	■	■	COD.	4 km/h	Euro	■	■
80x30	603101	120	4.80	12	300	604501	120	11.22	12	124	605901	120	8.59	6	124	606621	120	17.84	12	124
100x30	603102	170	5.67	12	300	604502	170	12.09	12	100	605902	170	9.46	6	100	606622	170	18.71	12	100
125x35	603103	230	8.80	6	180	604503	220	18.01	12	70	605903	220	13.77	6	70	606623	220	24.63	12	70
150x35	603105	250	9.43	6	120	604504	220	18.64	6	70	605904	220	14.40	6	70	606624	220	25.26	6	70
150x45	603104	350	12.11	6	120	604511	300	28.19	4	70	605911	300	22.56	4	70	606631	300	38.75	4	70
200x50	603106	450	22.25	4	50	604506	300	39.33	2	20	605906	300	33.22	2	20	606626	300	49.89	2	20

60																				
	COD.	4 km/h	Euro	■	■	COD.	4 km/h	Euro	■	■										
80x30	607801	120	11.22	12	124	606421	120	17.84	12	124										
100x30	607802	170	12.09	12	100	606422	170	18.71	12	100										
125x35	607803	220	18.01	6	70	606423	220	24.63	6	70										
150x35	607804	220	18.64	6	70	606424	220	25.26	6	70										
150x45	607811	300	28.19	4	70	606431	300	38.75	4	70										
200x50	607806	300	39.33	2	20	606426	300	49.89	2	20										

60																				
	COD.	4 km/h	Euro	■	■	COD.	4 km/h	Euro	■	■	COD.	4 km/h	Euro	■	■					
150x45	604711	350	32.65	4	70	605911	350	22.56	4	70	606831	350	45.04	4	70					
200x50	604706	450	44.25	2	20	605906	450	33.26	2	20	606826	450	56.64	2	20					

I RUOTE IN POLIURETANO TERMOPLASTICO (55 SHORE D), NUCLEO IN POLIAMMIDE 6

D RÄDER AUS THERMOPLASTISCHEM POLYURETHAN (55 SHORE D), POLYAMID 6 FELGE

GB THERMOPLASTIC POLYURETHANE WHEELS (55 SHORE D), POLYAMIDE 6 CENTRE

E RUEDAS DE POLIURETANO TERMOPLASTICO (55 SHORE D), NUCLEO DE POLIAMIDA 6

F ROUES EN POLYURETHANE THERMOPLASTIQUE (55 SHORE D), CORPS EN POLYAMIDE 6

RU КОЛЕСА ИЗ ТЕРМОПЛАСТИЧНОГО ПОЛИУРЕТАНА (55 ШОР D) ОСНОВАНИЕ ИЗ ПОЛИАМИДА 6

60

60																			
	COD.		Euro			COD.		Euro			COD.		Euro						
100x30	607302	170	24.72	12	100	608302	170	15.03	6	100	609102	170	31.34	12	100				
125x35	607303	230	28.46	12	70	608303	230	18.24	6	70	609103	230	35.09	12	70				

60																			
	COD.		Euro			COD.		Euro			COD.		Euro						
150x45	607504	350	44.68	4	70	608504	350	26.10	4	70	609104	350	61.29	4	70				
200x50	607506	450	58.89	2	20	608506	450	38.47	2	20	609106	450	75.50	2	20				

60																				
	COD.		Euro			COD.		Euro			COD.		Euro			COD.		Euro		
80x30	603201	120	6.25	12	300	604601	120	29.64	12	62	605601	120	18.91	6	62	606721	120	42.03	12	62
100x30	603202	170	7.12	12	300	604602	170	30.51	12	50	605602	170	19.78	6	50	606722	170	42.90	12	50
125x35	603203	230	11.28	6	180	604603	220	38.97	12	36	605603	220	26.82	6	36	606723	220	51.36	12	36
150x35	603205	250	11.91	6	120	604604	220	39.60	6	36	605604	220	27.45	6	36	606724	220	51.99	6	36
150x45	603204	350	14.59	6	120	604611	300	65.31	4	36	605611	300	45.20	4	36	606731	300	83.77	4	36
200x50	603206	450	26.39	4	50	604606	300	82.47	2	10	605606	300	60.09	2	10	606726	300	100.93	2	10

I RUOTE IN POLIURETANO TERMOPLASTICO (55 SHORE D), NUCLEO IN POLIAMMIDE 6

D RÄDER AUS THERMOPLASTISCHEM POLYURETHAN (55 SHORE D), POLYAMID 6 FELGE





















GB THERMOPLASTIC POLYURETHANE WHEELS (55 SHORE D), POLYAMIDE 6 CENTRE







E RUEDAS DE POLIURETANO TERMOPLASTICO (55 SHORE D), NUCLEO DE POLIAMIDA 6



F ROUES EN POLYURETHANE THERMOPLASTIQUE (55 SHORE D), CORPS EN POLYAMIDE 6

RU КОЛЕСА ИЗ ТЕРМОПЛАСТИЧНОГО ПОЛИУРЕТАНА (55 ШОР D) ОСНОВАНИЕ ИЗ ПОЛИАМИДА 6

60

60		INOX		INOX		INOX		INOX													
		 NLX		 NLX		 PX		 PX													
	COD.	4 km/h	Euro			COD.	4 km/h	Euro			COD.	4 km/h	Euro			COD.	4 km/h	Euro			
80x30	608001	120	29.64	12	62	608821	120	42.03	12	62											
100x30	608002	170	30.51	12	50	608822	170	42.90	12	50											
125x35	608003	220	38.97	6	36	608823	220	51.36	6	36											
150x35	608004	220	39.60	6	36	608824	220	51.99	6	36											
150x45	608011	300	65.31	4	36	608831	300	83.77	4	36	607314	350	123.70	4	36	607414	350	64.63	4	36	
200x50	608006	300	82.47	2	10	608826	300	100.93	2	10	607316	450	139.03	2	10	607416	450	79.54	2	10	

60		INOX																		
		 PX																		
	COD.	4 km/h	Euro																	
150x45	607514	350	157.84	4	36															
200x50	607516	450	173.17	2	10															

	 POLYAMIDE 6	 GALVANISED																		
	COD.	Euro				COD.	Euro													
80x30	100501	1.79				100461	2.02													
100x30	100502	1.79				100462	2.20													
125x35	100503	1.79				100463	2.37													
150x35	100504	2.62																		
150x45	100514	2.62																		
200x50	100506	3.41																		

Per ordinare ruote e supporti montati con parafili, indicare il suffisso PF dopo il codice del complessivo ruota e supporto
 To order castors fitted with threadguards, please add "PF" to the complete unit code
 Pour commander les roues et roulettes avec pare-fils montées on doit indiquer après le code de la référence le suffixe "PF"
 Falls ein Fadenschutz gewünscht wird, bitte der Artikel-Nr. die Abkürzung "PF" hinzufügen
 Para solicitar un artículo con placa anti-hilos se necesita la sigla PF despues del código del artículo de la rueda con soporte
 Чтобы заказать колеса и опоры с нитезащитным устройством, необходимо указать аббревиатуру PF после кода узла колесо + опора.

Accessori (contropiastre, codoli, bloccaggi direzionali, parapiedi) : pag 142-144
 Accessoires (counter-plates, stems, directional locks, footguards): page 142-144
 Accessoires (contre-platines, tiges, blocages directionnels, pare-pieds): page 142-144
 Zubehör (Gegenplatten, Zapfen, Richtungsfeststeller, Fußschutz): Seite 142-144
 Accesorios (contraplacas, espigas, posicionadores direccionales, guardapié): pág 142-144
 ДОПОЛНИТЕЛЬНЫЕ ПРИНАДЛЕЖНОСТИ (Панели, стержни, Фиксатор направления движения, Зашиты для ног): стр. 142-144

I RUOTE IN POLIURETANO TERMOPLASTICO (55 SHORE D), NUCLEO IN POLIAMMIDE 6

D RÄDER AUS THERMOPLASTISCHEM POLYURETHAN (55 SHORE D), POLYAMID 6 FELGE









GB THERMOPLASTIC POLYURETHANE WHEELS (55 SHORE D), POLYAMIDE 6 CENTRE









E RUEDAS DE POLIURETANO TERMOPLASTICO (55 SHORE D), NUCLEO DE POLIAMIDA 6









F ROUES EN POLYURETHANE THERMOPLASTIQUE (55 SHORE D), CORPS EN POLYAMIDE 6

RU КОЛЕСА ИЗ ТЕРМОПЛАСТИЧНОГО ПОЛИУРЕТАНА (55 ШОР D) ОСНОВАНИЕ ИЗ ПОЛИАМИДА 6

60

60																				
									COD.		4 km/h		Euro		::		::			
	COD.		4 km/h		Euro		::		::		COD.		4 km/h		Euro		::		::	
80x30	602201	130	6.46	12	300	604701	130	12.88	12	124	604801	130	10.25	6	124	604901	130	19.50	12	124
100x30	602202	200	7.33	12	300	604702	200	13.74	12	100	604802	200	11.12	6	100	604902	200	20.37	12	100
125x35	602203	250	10.35	6	180	604703	220	19.56	12	70	604803	220	15.32	6	70	604903	220	26.19	12	70
150x45	602204	350	16.87	6	120	604731	300	32.95	6	70	604811	300	27.32	6	70	604911	300	43.51	6	70
160x50	602210	400	19.15	4	120	604710	300	35.23	4	70	604810	300	29.60	4	70	604910	300	45.79	4	70
200x50	602206	450	26.39	4	50	604736	300	43.47	4	20	604806	300	37.36	4	20	604906	300	54.03	4	20
250x50	602208	750	46.38	2	24															

60																				
											COD.		4 km/h		Euro		::		::	
	COD.		4 km/h		Euro		::		::		COD.		4 km/h		Euro		::		::	
80x30	604301	130	12.88	12	124	605501	130	19.50	12	124										
100x30	604302	200	13.74	12	100	605502	200	20.37	12	100										
125x35	604303	220	19.56	6	70	605503	220	26.19	12	70										
150x45	604331	350	32.95	6	120	605511	300	43.51	6	70	608411	350	37.42	6	70	604811	300	27.32	6	70
160x50	604310	400	35.23	4	120	605510	300	45.79	4	70	608410	400	39.69	4	70	604810	300	29.60	4	70
200x50	604336	450	43.47	4	50	605506	300	54.03	4	20	608406	450	48.39	4	20	604806	300	37.36	4	20

60																				
											COD.		4 km/h		Euro		::		::	
	COD.		4 km/h		Euro		::		::		COD.		4 km/h		Euro		::		::	
100x30						608202	200	26.37	12	100	608222	200	16.38	6	100	608242	200	34.07	12	100
125x35						608203	250	30.02	12	70	608223	250	19.89	6	70	608243	250	36.64	12	70
150x45	608911	350	49.80	6	70															
160x50	608910	400	52.08	4	70															
200x50	608906	450	60.78	4	20															

I RUOTE IN POLIURETANO TERMOPLASTICO (55 SHORE D), NUCLEO IN POLIAMMIDE 6

D RÄDER AUS THERMOPLASTISCHEM POLYURETHAN (55 SHORE D), POLYAMID 6 FELGE

















GB THERMOPLASTIC POLYURETHANE WHEELS (55 SHORE D), POLYAMIDE 6 CENTRE





















E RUEDAS DE POLIURETANO TERMOPLASTICO (55 SHORE D), NUCLEO DE POLIAMIDA 6











F ROUES EN POLYURETHANE THERMOPLASTIQUE (55 SHORE D), CORPS EN POLYAMIDE 6

RU КОЛЕСА ИЗ ТЕРМОПЛАСТИЧНОГО ПОЛИУРЕТАНА (55 ШОР D) ОСНОВАНИЕ ИЗ ПОЛИАМИДА 6

60

60																
		 P	 P	 P												
	COD.	 4 km/h	Euro			COD.	 4 km/h	Euro			COD.	 4 km/h	Euro			
150x45	608211	350	49.44	6	70	608231	350	30.86	6	70	608251	350	66.05	6	70	
160x50	608210	400	51.72	4	70	608230	400	33.14	4	70	608250	400	68.33	4	70	
200x50	608206	450	63.03	4	20	608226	450	42.61	4	20	608246	450	79.64	4	20	
250x50	608208	750	88.30	1	8	608228	750	65.63	1	8	608248	750	104.91	1	8	

60		 INOX	 INOX	 INOX																
		 NLX	 NLX	 NLX																
	COD.	 4 km/h	Euro			COD.	 4 km/h	Euro			COD.	 4 km/h	Euro			COD.	 4 km/h	Euro		
80x30	602401	130	10.60	12	300	605401	130	33.99	12	62	605001	130	23.26	6	62	606901	130	46.38	12	62
100x30	602402	200	11.47	12	300	605402	200	34.86	12	50	605002	200	24.13	6	50	606902	200	47.25	12	50
125x35	602403	250	14.49	6	180	605403	220	42.18	12	36	605003	220	30.03	6	36	606903	220	54.57	12	36
150x45	602404	350	24.63	6	60	605411	300	75.35	6	36	605011	300	55.24	6	36	606911	300	93.81	6	36
160x50	602410	400	26.91	4	60	605410	300	77.63	4	36	605010	300	57.51	4	36	606910	300	96.09	4	36
200x50	602406	450	34.16	4	26	605406	300	90.23	4	10	605006	300	67.85	4	10	606906	300	108.70	4	10

60	 INOX	 INOX																		
		 NLX	 NLX																	
	COD.	 4 km/h	Euro			COD.	 4 km/h	Euro												
80x30	606301	130	33.99	12	62	606501	130	46.38	12	62										
100x30	606302	200	34.86	12	50	606502	200	47.25	12	50										
125x35	606303	220	42.18	12	36	606503	220	54.57	12	36										
150x45	606311	350	75.35	6	36	606511	300	93.81	6	36										
160x50	606310	400	77.63	4	36	606510	300	96.09	4	36										
200x50	606306	450	90.23	4	10	606506	300	108.70	4	10										

I RUOTE IN POLIURETANO TERMOPLASTICO
(55 SHORE D), NUCLEO IN POLIAMMIDE 6

D RÄDER AUS THERMOPLASTISCHEM POLYURETHAN (55
SHORE D), POLYAMID 6 FELGE

























GB THERMOPLASTIC POLYURETHANE WHEELS
(55 SHORE D), POLYAMIDE 6 CENTRE

E RUEDAS DE POLIURETANO TERMOPLASTICO
(55 SHORE D), NUCLEO DE POLIAMIDA 6

F ROUES EN POLYURETHANE THERMOPLASTIQUE
(55 SHORE D), CORPS EN POLYAMIDE 6

RU КОЛЕСА ИЗ ТЕРМОПЛАСТИЧНОГО ПОЛИУРЕТАНА (55
ШОР D) ОСНОВАНИЕ ИЗ ПОЛИАМИДА 6

60

60	INOX					INOX					INOX				
															
	COD.	 4 km/h	Euro			COD.	 4 km/h	Euro			COD.	 4 km/h	Euro		
150x45	609411	350	133.74	6	36	609811	350	74.66	6	36	609911	350	167.88	6	36
160x50	609410	400	136.02	4	36	609810	400	76.94	4	36	609910	400	170.15	4	36
200x50	609406	450	146.79	4	10	609806	450	87.30	4	10	609906	450	180.93	4	10

Accessori (contropiastre, codoli, bloccaggi direzionali, parapiedi) : pag 142-144

Accessories (counter-plates, stems, directional locks, footguards): page 142-144

Accessoires (contre-platines, tiges, blocages directionnels, pare-pieds): page 142-144

Zubehöre (Gegenplatten, Zapfen, Richtungsfeststeller, Fußschutz): Seite 142-144

Accesorios (contraplacas, espigas, posicionadores direccionales, guardapié): pag 142-144

ДОПОЛНИТЕЛЬНЫЕ ПРИНАДЛЕЖНОСТИ (Панели, стержни, Фиксатор направления движения, Защиты для ног): стр. 142-144

I RUOTE IN POLIURETANO TERMOPLASTICO (85 SHORE A), NUCLEO IN POLIAMMIDE 6

D RÄDER AUS THERMOPLASTISCHEM POLYURETHAN (85 SHORE A), POLYAMID 6 FELGE

GB THERMOPLASTIC POLYURETHANE WHEELS (85 SHORE A), POLYAMIDE 6 CENTRE

E RUEDAS DE POLIURETANO TERMOPLASTICO (85 SHORE A), NUCLEO DE POLIAMIDA 6

F ROUES EN POLYURETHANE THERMOPLASTIQUE (85 SHORE A), CORPS EN POLYAMIDE 6

RU КОЛЕСА ИЗ ТЕРМОПЛАСТИЧНОГО ПОЛИУРЕТАНА (85 ШОР А), ОСНОВАНИЕ ИЗ ПОЛИАМИДА 6

61

61



Diagram	Type 1					Type 2					Type 3					Type 4				
	COD.	4 km/h	Euro	■	■	COD.	4 km/h	Euro	■	■	COD.	4 km/h	Euro	■	■	COD.	4 km/h	Euro	■	■
80x30	611101	75	4.14	12	300	614201	75	10.56	12	124	615701	75	7.93	6	124	616601	75	17.18	12	124
100x30	611102	120	5.20	12	300	614202	120	11.61	12	100	615702	120	8.98	6	100	616602	120	18.24	12	100
125x35	611103	180	8.92	6	180	614203	180	18.13	12	70	615703	180	13.89	6	70	616603	180	24.76	12	70
150x35	611105	230	9.48	6	120	614204	220	18.69	6	70	615704	220	14.45	6	70	616604	220	25.32	6	70
150x45	611104	250	12.67	6	120	614211	250	28.75	6	70	615711	250	23.12	6	70	616611	250	39.31	6	70
200x50	611106	300	24.53	4	50	614206	300	41.61	2	20	615706	300	35.50	2	20	616606	300	52.16	2	20

61



Diagram	Type 1					Type 2					Type 3					Type 4				
	COD.	4 km/h	Euro	■	■	COD.	4 km/h	Euro	■	■	COD.	4 km/h	Euro	■	■	COD.	4 km/h	Euro	■	■
80x30	617701	75	10.56	12	124	616401	75	17.18	12	124										
100x30	617702	120	11.61	12	100	616402	120	18.24	12	100	616102	120	14.54	12	100	616202	120	21.17	12	100
125x35	617703	180	18.13	6	70	616403	180	24.76	6	70	616103	180	21.06	6	70	616203	180	27.69	6	70
150x35	617704	220	18.69	6	70	616404	220	25.32	6	70	616104	220	21.62	6	70	616204	220	28.25	6	70
150x45	617711	250	28.75	6	70	616411	250	39.31	6	70	616111	250	36.08	4	70	616211	250	46.64	4	70
200x50	617706	300	41.61	2	20	616406	300	52.16	2	20	616106	300	48.93	2	20	616206	300	59.49	2	20

61



Diagram	Type 1					Type 2					Type 3					Type 4				
	COD.	4 km/h	Euro	■	■	COD.	4 km/h	Euro	■	■	COD.	4 km/h	Euro	■	■	COD.	4 km/h	Euro	■	■
80x30	619201	75	15.42	12	124	619301	75	22.05	12	124	614401	75	27.53	12	62	615101	75	16.80	6	62
100x30	619202	120	16.48	12	100	619302	120	23.10	12	100	614402	120	28.59	12	50	615102	120	17.85	6	50
125x35	619203	130	23.00	6	70	619303	130	29.62	6	70	614403	180	36.61	12	36	615103	180	24.46	6	36
150x35											614404	220	37.17	6	36	615104	220	25.02	6	36
150x45											614411	250	63.38	6	36	615111	250	43.27	6	36
200x50											614406	300	80.61	2	10	615106	300	58.23	2	10

I RUOTE IN POLIURETANO TERMOPLASTICO (85 SHORE A), NUCLEO IN POLIAMMIDE 6

D RÄDER AUS THERMOPLASTISCHEM POLYURETHAN (85 SHORE A), POLYAMID 6 FELGE

GB THERMOPLASTIC POLYURETHANE WHEELS (85 SHORE A), POLYAMIDE 6 CENTRE

E RUEDAS DE POLIURETANO TERMOPLASTICO (85 SHORE A), NUCLEO DE POLIAMIDA 6

F ROUES EN POLYURETHANE THERMOPLASTIQUE (85 SHORE A), CORPS EN POLYAMIDE 6

RU КОЛЕСА ИЗ ТЕРМОПЛАСТИЧНОГО ПОЛИУРЕТАНА (85 ШОР А) ОСНОВАНИЕ ИЗ ПОЛИАМИДА 6

61

61	INOX					INOX					INOX				
	COD.	4 km/h	Euro	■	■	COD.	4 km/h	Euro	■	■	COD.	4 km/h	Euro	■	■
80x30	616701	75	39.92	12	62	617901	75	27.53	12	62	618801	75	39.92	12	62
100x30	616702	120	40.98	12	50	617902	120	28.59	12	50	618802	120	40.98	12	50
125x35	616703	180	49.00	12	36	617903	180	36.61	6	36	618803	180	49.00	6	36
150x35	616704	220	49.56	6	36	617904	220	37.17	6	36	618804	220	49.56	6	36
150x45	616711	250	81.85	6	36	617911	250	63.38	6	36	618811	250	81.85	6	36
200x50	616706	300	99.07	2	10	617906	300	80.61	2	10	618806	300	99.07	2	10

61						NL					NL					NL				
	COD.	4 km/h	Euro	■	■	COD.	4 km/h	Euro	■	■	COD.	4 km/h	Euro	■	■	COD.	4 km/h	Euro	■	■
80x30	613101	75	5.49	12	300	614501	75	11.90	12	124	615901	75	9.27	6	124	616621	75	18.53	12	124
100x30	613102	120	6.54	12	300	614502	120	12.96	12	100	615902	120	10.33	6	100	616622	120	19.58	12	100
125x35	613103	180	10.37	6	180	614503	180	19.58	12	70	615903	180	15.34	6	70	616623	180	26.21	12	70
150x35	613105	230	10.93	6	120	614504	220	20.14	6	70	615904	220	15.90	6	70	616624	220	26.77	6	70
150x45	613104	250	14.12	6	120	614511	250	30.20	6	70	615911	250	24.57	6	70	616631	250	40.76	6	70
200x50	613106	300	26.60	4	50	614506	300	43.68	2	20	615906	300	37.57	2	20	616626	300	54.23	2	20

61						NL					NL				
	COD.	4 km/h	Euro	■	■	COD.	4 km/h	Euro	■	■	COD.	4 km/h	Euro	■	■
80x30	617801	75	11.90	12	124	616421	75	18.53	12	124					
100x30	617802	120	12.96	12	100	616422	120	19.58	12	100					
125x35	617803	180	19.58	6	70	616423	180	26.21	6	70					
150x35	617804	220	20.14	6	70	616424	220	26.77	6	70					
150x45	617811	250	30.20	6	70	616431	250	40.76	6	70					
200x50	617806	300	43.68	2	20	616426	300	54.23	2	20					

I RUOTE IN POLIURETANO TERMOPLASTICO (85 SHORE A), NUCLEO IN POLIAMMIDE 6

D RÄDER AUS THERMOPLASTISCHEM POLYURETHAN (85 SHORE A), POLYAMID 6 FELGE





GB THERMOPLASTIC POLYURETHANE WHEELS (85 SHORE A), POLYAMIDE 6 CENTRE



E RUEDAS DE POLIURETANO TERMOPLASTICO (85 SHORE A), NUCLEO DE POLIAMIDA 6

F ROUES EN POLYURETHANE THERMOPLASTIQUE (85 SHORE A), CORPS EN POLYAMIDE 6

RU КОЛЕСА ИЗ ТЕРМОПЛАСТИЧНОГО ПОЛИУРЕТАНА (85 ШОР А) ОСНОВАНИЕ ИЗ ПОЛИАМИДА 6

61

61						 INOX NLX					 INOX NLX					 INOX NLX				
	COD.	4 km/h	Euro	■	■	COD.	4 km/h	Euro	■	■	COD.	4 km/h	Euro	■	■	COD.	4 km/h	Euro	■	■
80x30	613201	75	6.93	12	300	614601	75	30.33	12	62	615601	75	19.59	6	62	616721	75	42.71	12	62
100x30	613202	120	7.99	12	300	614602	120	31.38	12	50	615602	120	20.65	6	50	616722	120	43.77	12	50
125x35	613203	180	12.85	6	180	614603	180	40.54	12	36	615603	180	28.39	6	36	616723	180	52.93	12	36
150x35	613205	230	13.41	6	120	614604	220	41.10	6	36	615604	220	28.95	6	36	616724	220	53.49	6	36
150x45	613204	250	16.60	6	120	614611	250	67.32	6	36	615611	250	47.21	6	36	616731	250	85.78	6	36
200x50	613206	300	30.74	4	50	614606	300	86.82	2	10	615606	300	64.44	2	10	616726	300	105.28	2	10

61	 INOX NLX					 INOX NLX														
	COD.	4 km/h	Euro	■	■	COD.	4 km/h	Euro	■	■										
80x30	618001	75	30.33	12	62	618821	75	42.71	12	62										
100x30	618002	120	31.38	12	50	618822	120	43.77	12	50										
125x35	618003	180	40.54	6	36	618823	180	52.93	6	36										
150x35	618004	220	41.10	6	36	618824	220	53.49	6	36										
150x45	618011	250	67.32	6	36	618831	250	85.78	6	36										
200x50	618006	300	86.82	2	10	618826	300	105.28	2	10										

	● POLYAMIDE 6					● GALVANISED														
	COD.		Euro			COD.		Euro												
80x30	100501		1.79			100461		2.02												
100x30	100502		1.79			100462		2.20												
125x35	100503		1.79			100463		2.37												
150x35	100504		2.62																	
150x45	100514		2.62																	
200x50	100506		3.41																	

Per ordinare ruote e supporti montati con parafili, indicare il suffisso PF dopo il codice del complessivo ruota e supporto
 To order castors fitted with threadguards, please add "PF" to the complete unit code
 Pour commander les roues et roulettes avec pare-fils montés on doit indiquer après le code de la référence le suffixe "PF"
 Falls ein Fadenschutz gewünscht wird, bitte der Artikel-Nr. die Abkürzung "PF" hinzufügen
 Para solicitar un artículo con placa anti-hilos se necesita la sigla PF después del código del artículo de la rueda con soporte
 Чтобы заказать колеса и опоры с нитезащитным устройством, необходимо указать аббревиатуру PF после кода узла колесо + опора.

I RUOTE IN POLIURETANO TERMOPLASTICO
(85 SHORE A), NUCLEO IN POLIAMMIDE 6

D RÄDER AUS THERMOPLASTISCHEM POLYURETHAN
(85 SHORE A), POLYAMID 6 FELGE

































GB THERMOPLASTIC POLYURETHANE WHEELS
(85 SHORE A), POLYAMIDE 6 CENTRE































E RUEDAS DE POLIURETANO TERMOPLASTICO
(85 SHORE A), NUCLEO DE POLIAMIDA 6

F ROUES EN POLYURETHANE THERMOPLASTIQUE
(85 SHORE A), CORPS EN POLYAMIDE 6

RU КОЛЕСА ИЗ ТЕРМОПЛАСТИЧНОГО ПОЛИУРЕТАНА
(85 ШОР А) ОСНОВАНИЕ ИЗ ПОЛИАМИДА 6

61

61																						
																						
	COD.		Euro			COD.		Euro				COD.		Euro				COD.		Euro		
80x30	612201	85	7.14	12	300	614701	85	13.56	12	124		614801	85	10.93	6	124		614901	85	20.18	12	124
100x30	612202	120	8.20	12	300	614702	120	14.61	12	100		614802	120	11.99	6	100		614902	120	21.24	12	100
125x35	612203	180	11.92	6	180	614703	180	21.13	12	70		614803	180	16.89	6	70		614903	180	27.76	12	70
150x45	612204	250	18.88	6	120	614731	250	34.96	6	70		614811	250	29.33	6	70		614911	250	45.52	6	70
160x50	612210	275	23.29	4	120	614710	275	39.37	4	70		614810	275	33.74	4	70		614910	275	49.93	4	70
200x50	612206	300	30.74	4	50	614736	300	47.82	4	20		614806	300	41.71	4	20		614906	300	58.37	4	20

61																							
																							
	COD.		Euro			COD.		Euro															
80x30	614301	85	13.56	12	124	615501	85	20.18	12	124													
100x30	614302	120	14.61	12	100	615502	120	21.24	12	100													
125x35	614303	180	21.13	12	70	615503	180	27.76	12	70													
150x45	614331	250	34.96	6	70	615511	250	45.52	6	70													
160x50	614310	275	39.37	4	70	615510	275	49.93	4	70													
200x50	614336	300	47.82	4	20	615506	300	58.37	4	20													

I RUOTE IN POLIURETANO TERMOPLASTICO (85 SHORE A), NUCLEO IN POLIAMMIDE 6

D RÄDER AUS THERMOPLASTISCHEM POLYURETHAN (85 SHORE A), POLYAMID 6 FELGE





GB THERMOPLASTIC POLYURETHANE WHEELS (85 SHORE A), POLYAMIDE 6 CENTRE



E RUEDAS DE POLIURETANO TERMOPLASTICO (85 SHORE A), NUCLEO DE POLIAMIDA 6

F ROUES EN POLYURETHANE THERMOPLASTIQUE (85 SHORE A), CORPS EN POLYAMIDE 6

RU КОЛЕСА ИЗ ТЕРМОПЛАСТИЧНОГО ПОЛИУРЕТАНА (85 ШОР А) ОСНОВАНИЕ ИЗ ПОЛИАМИДА 6

61

61																				
	COD.	4 km/h	Euro	12	62	COD.	4 km/h	Euro	12	62	COD.	4 km/h	Euro	12	62	COD.	4 km/h	Euro	12	62
80x30	612401	85	11.28	12	300	615401	85	34.67	12	62	615001	85	23.94	6	62	616901	85	47.06	12	62
100x30	612402	120	12.34	12	300	615402	120	35.73	12	50	615002	120	25.00	6	50	616902	120	48.12	12	50
125x35	612403	180	16.06	6	180	615403	180	43.75	12	36	615003	180	31.60	6	36	616903	180	56.14	12	36
150x45	612404	250	26.64	6	60	615411	250	77.36	6	36	615011	250	57.25	6	36	616911	250	95.82	6	36
160x50	612410	275	31.05	4	60	615410	275	81.77	4	36	615010	275	61.65	4	36	616910	275	100.23	4	36
200x50	612406	300	38.50	4	26	615406	300	94.58	4	10	615006	300	72.20	4	10	616906	300	113.04	4	10

61																				
	COD.	4 km/h	Euro	12	62	COD.	4 km/h	Euro	12	62										
80x30	616301	85	34.67	12	62	616501	85	47.06	12	62										
100x30	616302	120	35.73	12	50	616502	120	48.12	12	50										
125x35	616303	180	43.75	12	36	616503	180	56.14	12	36										
150x45	616311	250	77.36	6	36	616511	250	95.82	6	36										
160x50	616310	275	81.77	4	36	616510	275	100.23	4	36										
200x50	616306	300	94.58	4	10	616506	300	113.04	4	10										

I RUOTE IN POLIURETANO TR-ROLL,
NUCLEO IN ALLUMINIO

D TR-ROLL POLYURETHAN-RÄDER,
ALUKERN







GB TR-ROLL POLYURETHANE WHEELS,
ALUMINIUM CENTRE







E RUEDAS DE POLIURETANO TR-ROLL,
NUCLEO DE ALUMINIO







F ROUES EN POLYURETHANE TR-ROLL,
CORPS EN ALUMINIUM

RU КОЛЕСА ИЗ ПОЛИУРЕТАНА ТР,
ОСНОВАНИЕ ИЗ АЛЮМИНИЯ

62BS

62BS															
	COD.	 4 km/h	Euro	12	62	COD.	 4 km/h	Euro	12	62	COD.	 4 km/h	Euro	12	62
80x25	622181	160	19.53	12	150	624181	160	13.97	12	150	625951	160	25.95	12	62
100x30	622182	200	24.30	12	150	624182	200	18.47	12	150	625952	200	30.72	12	50
125x35	622183	250	26.36	6	90	624183	250	20.54	6	90	625953	220	35.57	12	36
150x40	622184	450	35.01	4	60	624184	450	26.75	4	60	625954	300	51.10	4	36
160x50	622185	550	42.22	4	60	624185	550	33.95	4	60	625960	300	58.30	4	16
200x50	622186	700	55.58	4	26	624186	700	45.78	4	26	625956	300	72.66	2	10

62BS																				
	COD.	 4 km/h	Euro	12	62	COD.	 4 km/h	Euro	12	62	COD.	 4 km/h	Euro	12	62					
80x25	627151	160	32.57	12	62															
100x30	627152	200	37.34	12	50															
125x35	627153	220	42.20	12	36															
150x40	627154	300	61.65	4	36	624514	450	55.56	4	36	626754	450	45.47	4	36					
160x50	627160	300	68.86	4	16	624510	500	62.76	4	16	626760	500	52.67	4	16					
200x50	627156	300	83.21	2	10	624516	500	77.57	2	10	626756	500	66.55	2	10					

62BS																				
	COD.	 4 km/h	Euro	12	62	COD.	 4 km/h	Euro	12	62	COD.	 4 km/h	Euro	12	62					
100x30	627612	200	43.35	12	50	628542	200	33.66	12	50	627212	200	49.97	12	50					
125x35	627633	250	46.03	12	36	628543	250	35.90	12	36	627233	250	52.65	12	36					
150x40	627614	450	67.59	4	36	628544	450	49.01	4	36										
160x50	627620	600	74.79	4	16	628550	600	56.21	4	16										
200x50	627616	700	92.22	2	10	628546	700	71.80	2	10										

I RUOTE IN POLIURETANO TR-ROLL AD ALTO SPESSORE, NUCLEO IN ALLUMINIO

D TR-ROLL POLYURETHANE-RÄDER HOHE DICKE, ALUKERN

GB TR-ROLL HIGH THICKNESS POLYURETHANE WHEELS, ALUMINIUM CENTRE

E RUEDAS DE POLIURETANO TR-ROLL ALTO ESPESOR, NUCLEO DE ALUMINIO



F ROUES EN POLYURETHANE TR-ROLL HAUT EPAISSEUR, CORPS EN ALUMINIUM

RU КОЛЕСА ИЗ ПОЛИУРЕТАНА TR-ROLL ВЫСОКОЙ ПЛОТНОСТИ, ОСНОВАНИЕ ИЗ АЛЮМИНИЯ

62AL





62AL



																				
	COD.	4 km/h	Euro	■	■	COD.	4 km/h	Euro	■	■										
100x40	622102	300	34.24	12	150	624102	300	28.17	12	150										
125x40 Im 40	622113	350	47.98	6	90	624113	350	39.81	6	90										
125x40 Im 50	622103	350	48.77	6	90	624103	350	40.59	6	90										
160x50 F. 20	622104	550	54.30	4	60	624104	550	46.12	4	60										
160x50 F. 25	622114	550	54.50	4	60															
180x50	622105	600	62.44	4	26	624105	600	54.27	4	26										
200x50 F. 20	622106	700	70.26	4	26	624106	700	62.08	4	26										
200x50 F. 25	622116	700	70.46	4	26															
250x50	622108	800	88.26	1	24	624108	800	79.26	1	24										





62AL



																				
	COD.	4 km/h	Euro	■	■	COD.	4 km/h	Euro	■	■	COD.	4 km/h	Euro	■	■	COD.	4 km/h	Euro	■	■
100x40	624402	200	40.65	12	50	626202	200	38.03	12	50	627302	200	47.28	12	50					
125x40	624413	220	57.19	12	36	626213	220	52.95	6	36	627313	220	63.82	12	36					
125x40 P.G.	624403	300	62.56	4	36	626203	300	57.73	4	36	627303	300	69.18	4	36	624903	300	73.03	4	36
160x50	624410	300	70.38	4	16	627704	300	64.75	4	16	627304	300	80.98	4	16	624910	300	85.08	4	16
200x50	624406	300	87.29	2	10	627706	300	81.23	2	10	627306	300	97.89	2	10	624916	300	102.03	2	10

62AL



																				
	COD.	4 km/h	Euro	■	■	COD.	4 km/h	Euro	■	■	COD.	4 km/h	Euro	■	■	COD.	4 km/h	Euro	■	■
160x50	624804	300	85.08	4	16	624504	500	74.84	4	16	627704	500	64.75	4	16	627404	500	87.23	4	16
200x50	624806	300	102.03	2	10	624506	500	92.25	2	10	627706	500	81.23	2	10	627406	500	104.64	2	10

I RUOTE IN POLIURETANO TR-ROLL AD ALTO SPESSORE, NUCLEO IN ALLUMINIO

D TR-ROLL POLYURETHANE-RÄDER HOHE DICKE, ALUKERN

GB TR-ROLL HIGH THICKNESS POLYURETHANE WHEELS, ALUMINIUM CENTRE

E RUEDAS DE POLIURETANO TR-ROLL ALTO ESPESOR, NUCLEO DE ALUMINIO

F ROUES EN POLYURETHANE TR-ROLL HAUT EPAISSEUR, CORPS EN ALUMINIUM

RU КОЛЕСА ИЗ ПОЛИУРЕТАНА TR-ROLL ВЫСОКОЙ ПЛОТНОСТИ, ОСНОВАНИЕ ИЗ АЛЮМИНИЯ

62_{AL}

62_{AL}

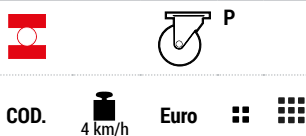

	COD.	4 km/h	Euro	■	■	COD.	4 km/h	Euro	■	■	COD.	4 km/h	Euro	■	■
100x40	627602	300	53.28	6	50	628512	300	43.59	6	50	627202	300	59.91	6	50
125x40	627613	300	67.65	6	36	628513	300	57.53	4	36	627213	300	74.27	4	36

62_{AL}



	COD.	4 km/h	Euro	■	■	COD.	4 km/h	Euro	■	■	COD.	4 km/h	Euro	■	■
125x40 P.G.	627603	350	76.45	4	36	628503	350	60.24	4	36	627203	350	93.06	4	36
160x50	627610	550	86.87	4	16	628514	550	68.29	4	16	627204	550	103.48	4	16
180x50	627605	600	99.08	4	16	628515	600	78.66	4	16	627205	600	115.69	4	16
200x50	627516	700	106.89	2	10	628516	700	86.47	2	10	627206	700	123.51	2	10
250x50	627608	750	130.18	1	8	628518	750	107.52	1	8	627208	750	146.79	1	8

62_{AL}



	COD.	4 km/h	Euro	■	■	COD.	4 km/h	Euro	■	■	COD.	4 km/h	Euro	■	■
125x40	625003	350	80.07	4	36	628503	350	60.24	4	36	629903	350	96.68	4	36
160x50	625010	550	90.49	4	16	628514	550	68.29	4	16	629904	550	107.10	4	16
180x50	625005	600	103.01	4	16	628515	600	78.66	4	16	629905	600	119.63	4	16
200x50	625016	700	110.83	2	10	628516	700	86.47	2	10	629906	700	127.44	2	10

62_{AL}

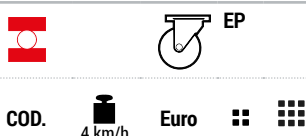

	COD.	4 km/h	Euro	■	■	COD.	4 km/h	Euro	■	■	COD.	4 km/h	Euro	■	■
160x50	627824	550	142.79	4	16	628824	550	85.96	4	16	626664	550	159.40	2	16
200x50	627826	700	161.34	2	10	628826	700	104.98	2	10	626656	700	177.95	1	10

I RUOTE IN POLIURETANO TR-ROLL AD ALTO SPESSORE, NUCLEO IN ALLUMINIO

D TR-ROLL POLYURETHANE-RÄDER HOHE DICKE, ALUKERN

GB TR-ROLL HIGH THICKNESS POLYURETHANE WHEELS, ALUMINIUM CENTRE

E RUEDAS DE POLIURETANO TR-ROLL ALTO ESPESOR, NUCLEO DE ALUMINIO

F ROUES EN POLYURETHANE TR-ROLL HAUT EPAISSEUR, CORPS EN ALUMINIUM

RU КОЛЕСА ИЗ ПОЛИУРЕТАНА TR-ROLL ВЫСОКОЙ ПЛОТНОСТИ, ОСНОВАНИЕ ИЗ АЛЮМИНИЯ

62AL

62AL



COD.	4 km/h	Euro	EE MHD		COD.	4 km/h	Euro	EE MHD		COD.	4 km/h	Euro	EE MHD	
			■	■				■	■					
100x40	628302	300	116.70	2 50	628402	300	73.95	2 50	628602	300	147.61	2 50		
125x40	628303	350	131.23	2 36	628403	350	88.48	2 36	628603	350	162.14	2 36		
160x50	628314	550	136.75	2 16	628414	550	94.01	2 16	628614	550	167.88	2 16		
180x50	628305	600	144.90	1 16	628405	600	102.15	1 16	628605	600	175.82	1 16		
200x50	628306	700	152.71	1 10	628406	700	109.97	1 10	628606	700	183.63	1 10		

62AL



COD.	4 km/h	Euro	EEG MHD		COD.	4 km/h	Euro	EEG MHD		COD.	4 km/h	Euro	EEG HD		COD.	4 km/h	Euro	EEG HD	
			■	■				■	■										
100x(40+40)	628062	600	169.32	2 50	628162	600	123.64	2 50											
125x(40+40)	628063	700	209.12	2 36	628163	700	157.31	2 36											
160x(50+50)										628084	1100	343.41	1 16	628184	1100	208.34	1 16		
200x(50+50)										628066	1400	375.33	1 10	628166	1400	240.25	1 10		

62AL



COD.	4 km/h	Euro	EES MHD		COD.	4 km/h	Euro	EES MHD		COD.	4 km/h	Euro	EES MHD	
			■	■				■	■					
160x50	626304	550	258.92	2 16	626404	550	215.96	2 16	626504	550	300.32	2 16		
200x50	626306	700	274.67	1 10	626406	700	231.72	1 10	626506	700	316.07	1 10		
250x50	626308	800	349.08	1 8	626408	800	273.53	1 8	626508	800	390.48	1 8		

Accessori (contropiastre, codoli, bloccaggi direzionali, parapiedi) : pag 142-144

Accessories (counter-plates, stems, directional locks, footguards): page 142-144

Accessoires (contre-platines, tiges, blocages directionnels, pare-pieds): page 142-144

Zubehöre (Gegenplatten, Zapfen, Richtungsfeststeller, Fußschutz): Seite 142-144

Accesorios (contraplacas, espigas, posicionadores direccionales, guardapié): pág 142-144

ДОПОЛНИТЕЛЬНЫЕ ПРИНАДЛЕЖНОСТИ (Панели, стержни, Фиксатор направления движения, Защиты для ног): стр. 142-144

I RUOTE IN POLIURETANO TR-ROLL CON PROFILO BOMBATO ERGONOMICO, NUCLEO IN ALLUMINIO

D TR-ROLL POLYURETHAN-RÄDER MIT LEICHT BALLIGEM PROFIL,ALUKERN

GB TR-ROLL POLYURETHANE WHEELS WITH ERGONOMIC ROUND PROFILE, ALUMINIUM CENTRE

E RUEDAS DE POLIURETANO TR-ROLL CON PERFIL REDONDO ERGONOMICO, NUCLEO DE ALUMINIO

F ROUES EN POLYURETHANE TR-ROLL AVEC PROFIL ERGONOMIQUE ROND, CORPS EN ALUMINIUM

RU КОЛЕСА ИЗ ПОЛИУРЕТАНА TR-ROLL С ЗАКРУГЛЕННЫМ ПРОФИЛЕМ ОСНОВАНИЕ ИЗ АЛЮМИНИЯ

62ER

62ER



	COD.	4 km/h	Euro	⏏	⏏	COD.	4 km/h	Euro	⏏	⏏
100x40	622142	200	35.26	12	150	624142	200	32.27	12	150
125x40 lm 40	622163	350	49.42	6	90	624163	350	41.24	6	90
125x40 lm 50	622143	350	49.42	6	90	624143	350	40.21	6	90
125x50	622153	450	51.46	6	90	624153	450	43.28	6	90
160x50	622144	550	56.14	4	60	624144	550	47.96	4	60
200x50	622146	700	72.37	4	26	624146	700	64.19	4	26
250x50	622148	800	90.91	4	24	624148	800	81.64	4	24

62ER



NL



NL



NL

	COD.	4 km/h	Euro	⏏	⏏	COD.	4 km/h	Euro	⏏	⏏	COD.	4 km/h	Euro	⏏	⏏
100x40	628702	200	41.79	12	50	628802	200	39.16	12	50	628902	200	48.42	12	50
125x40	628703	220	58.63	12	36	628803	220	54.39	6	36	628903	220	65.26	12	36
125x40	628713	300	63.21	4	36	628813	300	58.38	4	36	628913	300	69.83	4	36
160x50	628704	300	72.22	4	16	628204	300	66.59	4	16	628904	300	82.78	4	16
200x50	628716	300	89.44	2	10	628206	300	83.34	2	10	628916	300	100.00	2	10

62ER



M



M



M

	COD.	4 km/h	Euro	⏏	⏏	COD.	4 km/h	Euro	⏏	⏏	COD.	4 km/h	Euro	⏏	⏏
160x50	624604	500	76.68	4	16	628204	500	66.59	4	16	627904	500	89.07	4	16
200x50	624606	500	94.36	2	10	628206	500	83.34	2	10	627906	500	106.75	2	10

62ER



P



P



P

	COD.	4 km/h	Euro	⏏	⏏	COD.	4 km/h	Euro	⏏	⏏	COD.	4 km/h	Euro	⏏	⏏
125x40	629023	350	69.09	4	36	629123	350	58.78	4	36	629523	350	75.71	4	36

I RUOTE IN POLIURETANO TR-ROLL CON PROFILO BOMBATO ERGONOMICO, NUCLEO IN ALLUMINIO

D TR-ROLL POLYURETHAN-RÄDER MIT LEICHT BALLIGEM PROFIL,ALUKERN











GB TR-ROLL POLYURETHANE WHEELS WITH ERGONOMIC ROUND PROFILE, ALUMINIUM CENTRE











E RUEDAS DE POLIURETANO TR-ROLL CON PERFIL REDONDO ERGONOMICO, NUCLEO DE ALUMINIO











F ROUES EN POLYURETHANE TR-ROLL AVEC PROFIL ERGONOMIQUE ROND, CORPS EN ALUMINIUM











RU КОЛЕСА ИЗ ПОЛИУРЕТАНА TR-ROLL С ЗАКРУГЛЕННЫМ ПРОФИЛЕМ ОСНОВАНИЕ ИЗ АЛЮМИНИЯ

62ER

62ER							ERGO WORKPLACE								
															
	COD.	4 km/h	Euro	■ ■ ■ ■	COD.	4 km/h	Euro	■ ■ ■ ■	COD.	4 km/h	Euro	■ ■ ■ ■			
125x40 P.G.	629003	350	77.10	4	36	629103	350	60.89	4	36	629203	350	93.71	4	36
125x50 P.G.	629013	450	79.14	4	36	629113	450	62.93	4	36	629213	450	95.75	4	36
160x50	629004	550	88.71	4	16	629104	550	70.13	4	16	629204	550	105.32	4	16
200x50	629006	700	109.01	2	10	629106	700	88.59	2	10	629206	700	125.62	2	10

62ER							ERGO WORKPLACE								
															
	COD.	4 km/h	Euro	■ ■ ■ ■	COD.	4 km/h	Euro	■ ■ ■ ■	COD.	4 km/h	Euro	■ ■ ■ ■			
125x50	629033	450	82.76	4	36	629113	450	62.93	4	36	629233	450	99.37	4	36
160x50	629034	550	92.33	4	16	629104	550	70.13	4	16	629234	550	108.94	4	16
200x50	629036	700	112.94	2	10	629106	700	88.59	2	10	629236	700	129.55	2	10

62ER							ERGO WORKPLACE								
															
	COD.	4 km/h	Euro	■ ■ ■ ■	COD.	4 km/h	Euro	■ ■ ■ ■	COD.	4 km/h	Euro	■ ■ ■ ■			
160x50	629304	550	144.63	4	16	629404	550	87.80	4	16	629504	550	161.24	2	16
200x50	629306	700	163.45	2	10	629406	700	107.09	2	10	629506	700	180.01	1	10

62ER							ERGO WORKPLACE								
															
	COD.	4 km/h	Euro	■ ■ ■ ■	COD.	4 km/h	Euro	■ ■ ■ ■	COD.	4 km/h	Euro	■ ■ ■ ■			
125x40	629603	350	131.88	2	36	629703	350	89.13	2	36	629803	350	162.80	2	36
125x50	629613	450	133.92	2	36	629713	450	91.17	2	36	629813	450	164.83	2	36
160x50	629604	550	138.60	2	16	629704	550	95.85	2	16	629804	550	169.51	2	16
200x50	629606	700	154.83	1	10	629706	700	112.08	1	10	629806	700	185.74	1	10

I RUOTE IN POLIURETANO TR-ROLL CON PROFILO BOMBATO ERGONOMICO, NUCLEO IN ALLUMINIO

D TR-ROLL POLYURETHAN-RÄDER MIT LEICHT BALLIGEM PROFIL,ALUKERN























GB TR-ROLL POLYURETHANE WHEELS WITH ERGONOMIC ROUND PROFILE, ALUMINIUM CENTRE

E RUEDAS DE POLIURETANO TR-ROLL CON PERFIL REDONDO ERGONOMICO, NUCLEO DE ALUMINIO

F ROUES EN POLYURETHANE TR-ROLL AVEC PROFIL ERGONOMIQUE ROND, CORPS EN ALUMINIUM

RU КОЛЕСА ИЗ ПОЛИУРЕТАНА TR-ROLL С ЗАКРУГЛЕННЫМ ПРОФИЛЕМ ОСНОВАНИЕ ИЗ АЛЮМИНИЯ

62_{ER}

 	 					 					 				
															
	COD.	 4 km/h	Euro			COD.	 4 km/h	Euro			COD.	 4 km/h	Euro		
160x50	626804	550	260.55	2 16	626904	550	217.60	2 16		627004	550	301.95	2 16		
200x50	626806	700	276.78	1 10	626906	700	233.83	1 10		627006	700	318.18	1 10		

Accessori (contropiastre, codoli, bloccaggi direzionali, parapiedi) : pag 142-144

Accessories (counter-plates, stems, directional locks, footguards): page 142-144

Accessoires (contre-platines, tiges, blocages directionnels, pare-pieds): page 142-144

Zubehöre (Gegenplatten, Zapfen, Richtungsfeststeller, Fußschutz): Seite 142-144

Accesorios (contraplacas, espigas, posicionadores direccionales, guardapié): pag 142-144

ДОПОЛНИТЕЛЬНЫЕ ПРИНАДЛЕЖНОСТИ (Панели, стержни, Фиксатор направления движения, Зашиты для ног): стр. 142-144

I RUOTE IN POLIURETANO TR-ROLL,
NUCLEO IN GHISA MECCANICA

D TR-ROLL POLYURETHAN-RÄDER,
GÜßEISENKERN

GB TR-ROLL POLYURETHANE WHEELS,
CAST IRON CENTRE

E RUEDAS DE POLIURETANO TR-ROLL,
NUCLEO DE FERRO FUNDIDO

F ROUES EN POLYURETHANE TR-ROLL,
CORPS EN FONTE MECANIQUE

RU КОЛЕСА ИЗ ПОЛИУРЕТАНА TR-ROLL,
ОСНОВАНИЕ ИЗ МЕХАНИЧЕСКОГО ЧУГУНА

62GH

62GH



COD.	4 km/h	Euro	■ ■		COD.	4 km/h	Euro	■ ■		
			■ ■	■ ■				■ ■	■ ■	
200x50	622126	800	78.76	4	26	624126	800	70.59	4	26
200x80	622136	900	132.62	1	26	624136	900	120.90	1	26
250x80	622127	1200	180.09	1	24	624127	1200	168.36	1	24
300x80	622128	1400	243.06	1	12	624128	1400	231.02	1	12
400x100	622109	1700	722.50	1	4	624109	1700	685.78	1	4

62GH



COD.	4 km/h	Euro	■ ■		COD.	4 km/h	Euro	■ ■		COD.	4 km/h	Euro	■ ■		
			■ ■	■ ■				■ ■	■ ■						
200x50	627646	800	119.34	2	10	628656	800	94.98	2	10	627246	800	135.95	2	10

62GH



COD.	4 km/h	Euro	■ ■		COD.	4 km/h	Euro	■ ■		COD.	4 km/h	Euro	■ ■		
			■ ■	■ ■				■ ■	■ ■						
200x50	628316	800	161.22	1	10	628416	800	118.48	1	10	628616	800	192.14	1	10

62GH



COD.	4 km/h	Euro	■ ■		COD.	4 km/h	Euro	■ ■		COD.	4 km/h	Euro	■ ■		
			■ ■	■ ■				■ ■	■ ■						
200x80	628706	900	272.99	1	10	628806	900	198.58	1	10	628906	900	303.91	1	10
250x80	628708	1200	320.46	1	8	628808	1200	246.04	1	8	628908	1200	351.37	1	8
300x80	628718	1400	412.27	1	4	628818	1400	320.29	1	4	628918	1400	443.19	1	4

62_{GH}

I RUOTE IN POLIURETANO TR-ROLL,
NUCLEO IN GHISA MECCANICA

D TR-ROLL POLYURETHAN-RÄDER,
GÜßEISENKERN

GB TR-ROLL POLYURETHANE WHEELS,
CAST IRON CENTRE

E RUEDAS DE POLIURETANO TR-ROLL,
NUCLEO DE FERRO FUNDIDO

F ROUES EN POLYURETHANE TR-ROLL,
CORPS EN FONTE MECANIQUE

RU КОЛЕСА ИЗ ПОЛИУРЕТАНА TR-ROLL,
ОСНОВАНИЕ ИЗ МЕХАНИЧЕСКОГО ЧУГУНА

62_{GH}



EE
EHD



EE
EHD

COD.



4 km/h

Euro



COD.



4 km/h

Euro



400x100

628729

1700

1125.52

1

2

628829

1700

901.00

1

2

62_{GH}



EES
MHD



EES
MHD



EES
MHD

COD.



4 km/h

Euro



COD.



4 km/h

Euro



COD.



4 km/h

Euro



200x50

625706

800

283.18

1

10

625806

800

240.22

1

10

626006

800

324.58

1

10

Accessori (contropiastre, codoli, bloccaggi direzionali, parapiedi) : pag 142-144

Accessories (counter-plates, stems, directional locks, footguards): page 142-144

Accessoires (contre-platines, tiges, blocages directionnels, pare-pieds): page 142-144

Zubehöre (Gegenplatten, Zapfen, Richtungsfeststeller, Fußschutz): Seite 142-144

Accesorios (contraplacas, espigas, posicionadores direccionales, guardapié): pag 142-144

ДОПОЛНИТЕЛЬНЫЕ ПРИНАДЛЕЖНОСТИ (Панели, стержни, Фиксатор направления движения, Зашиты для ног): стр. 142-144

I RUOTE IN POLIURETANO TR-ROLL,
NUCLEO IN POLIAMMIDE 6

D TR-ROLL POLYURETHAN-RÄDER,
KERN AUS POLYAMID 6

GB TR-ROLL POLYURETHANE WHEELS,
POLYAMIDE 6 CENTRE

E RUEDAS DE POLIURETANO TR-ROLL,
NUCLEO DE POLIAMIDA 6

F ROUES EN POLYURETHANE TR-ROLL,
CORPS EN POLYAMIDE 6

RU КОЛЕСА ИЗ ПОЛИУРЕТАНА TR-ROLL,
ОСНОВАНИЕ ИЗ ПОЛИАМИДА 6

62_{NY}

62_{NY}



	COD.	4 km/h	Euro	■	■	COD.	4 km/h	Euro	■	■	COD.	4 km/h	Euro	■	■
100x40	622302	230	30.09	12	150	622402	230	34.46	12	150	624302	230	24.02	12	150
125x40	622303	280	32.23	6	90	622403	280	36.60	6	90	624303	280	26.16	6	90
125x40ER	622603	250	33.19	6	90	622503	250	37.56	6	90	624603	250	27.13	6	90
160x50	622304	400	43.48	4	60	622404	400	48.93	4	60	624304	400	35.30	4	60
160x50ER	622604	400	44.78	4	60	622504	400	50.24	4	60	624704	400	36.61	4	60
200x50	622306	500	55.59	4	26	622406	500	61.04	4	26	624306	500	47.41	4	26
200x50ER	622606	500	57.26	4	26	622506	500	62.71	4	26	624706	500	49.08	4	26

62_{NY}



	COD.	4 km/h	Euro	■	■	COD.	4 km/h	Euro	■	■	COD.	4 km/h	Euro	■	■
100x40	624422	200	36.50	12	50	626222	200	33.88	6	50	627322	200	43.13	12	50
125x40	624423	220	41.44	12	36	626223	220	37.20	6	36	627323	220	48.07	12	36
125x40ER	629303	220	42.40	12	36	629403	220	38.16	6	36	629503	220	49.03	12	36
160x50	624434	300	59.56	4	16	627724	300	53.93	4	16	627334	300	70.12	4	16
160x50ER	624424	300	60.87	4	16	627734	300	55.24	4	16	627324	300	71.43	4	16
200x50	624436	300	72.67	2	10	627726	300	66.56	2	10	627336	300	83.22	2	10
200x50ER	624426	300	74.33	2	10	627736	300	68.23	2	10	627326	300	84.89	2	10

62_{NY}



	COD.	4 km/h	Euro	■	■	COD.	4 km/h	Euro	■	■	COD.	4 km/h	Euro	■	■
160x50	624544	400	64.03	4	16	627724	400	53.93	4	16	627444	400	76.41	4	16
160x50ER	624534	400	65.33	4	16	627734	400	55.24	4	16	627434	400	77.72	4	16
200x50	624546	500	77.58	2	10	627726	500	66.56	2	10	627446	500	89.97	2	10
200x50ER	624536	500	79.25	2	10	627736	500	68.23	2	10	627436	500	91.64	2	10

I RUOTE IN POLIURETANO TR-ROLL,
NUCLEO IN POLIAMMIDE 6

D TR-ROLL POLYURETHAN-RÄDER,
KERN AUS POLYAMID 6

























GB TR-ROLL POLYURETHANE WHEELS,
POLYAMIDE 6 CENTRE

























E RUEDAS DE POLIURETANO TR-ROLL,
NUCLEO DE POLIAMIDA 6

F ROUES EN POLYURETHANE TR-ROLL,
CORPS EN POLIAMIDE 6

RU КОЛЕСА ИЗ ПОЛИУРЕТАНА TR-ROLL,
ОСНОВАНИЕ ИЗ ПОЛИАМИДА 6

62_{NY}

62 _{NY}															
															
	COD.	 4 km/h	Euro			COD.	 4 km/h	Euro			COD.	 4 km/h	Euro		
100x40	627622	230	49.13	6	50	628522	230	39.44	6	50	627222	230	55.76	6	50
125x40	627623	280	51.89	6	36	628523	280	41.77	6	36	627223	280	58.52	4	36
125x40ER	629313	250	52.86	6	36	629413	250	42.74	6	36	629513	250	59.48	4	36

62 _{NY}															
															
	COD.	 4 km/h	Euro			COD.	 4 km/h	Euro			COD.	 4 km/h	Euro		
160x50	627634	400	76.05	4	16	628534	400	57.47	4	16	627234	400	92.66	4	16
160x50ER	627624	400	77.36	4	16	628524	400	58.78	4	16	627224	400	93.97	4	16
200x50	627636	500	92.23	2	10	628536	500	71.81	2	10	627236	500	109.53	2	10
200x50ER	627626	500	93.90	2	10	628526	500	73.47	2	10	627226	500	110.51	2	10

I RUOTE IN POLIURETANO TR-ROLL,
NUCLEO IN POLIAMMIDE 6

D TR-ROLL POLYURETHAN-RÄDER,
KERN AUS POLYAMID 6















GB TR-ROLL POLYURETHANE WHEELS,
POLYAMIDE 6 CENTRE















E RUEDAS DE POLIURETANO TR-ROLL,
NUCLEO DE POLIAMIDA 6

F ROUES EN POLYURETHANE TR-ROLL,
CORPS EN POLYAMIDE 6

RU КОЛЕСА ИЗ ПОЛИУРЕТАНА TR-ROLL,
ОСНОВАНИЕ ИЗ ПОЛИАМИДА 6

62_{NY}

62 _{NY}															
															
	COD.	 4 km/h	Euro			COD.	 4 km/h	Euro			COD.	 4 km/h	Euro		
100x40	625122	200	57.85	12	50	625222	200	47.11	6	50	625322	200	70.24	12	50
125x40	625123	220	64.28	12	36	625223	220	52.13	6	36	625323	220	76.67	12	36
125x40ER	625103	220	65.25	12	36	625203	220	53.10	6	36	625303	220	77.64	12	36
160x50	625134	300	99.65	4	16	625234	300	79.54	4	16	625334	300	118.11	4	16
160x50ER	625124	300	100.95	4	16	625224	300	80.84	4	16	625324	300	119.42	4	16
200x50	625136	300	117.12	2	10	625236	300	94.74	2	10	625336	300	135.59	2	10
200x50ER	625126	300	118.79	2	10	625226	300	96.41	2	10	625326	300	137.25	2	10

62 _{NY}															
															
	COD.	 4 km/h	Euro			COD.	 4 km/h	Euro			COD.	 4 km/h	Euro		
160x50	625434	400	158.04	4	16	625534	400	98.97	4	16	625634	400	192.18	4	16
160x50ER	625424	400	159.35	4	16	625524	400	100.27	4	16	625624	400	193.48	4	16
200x50	625436	500	173.68	2	10	625536	500	114.19	2	10	625636	500	207.82	2	10
200x50ER	625426	500	175.35	2	10	625526	500	115.86	2	10	625626	500	209.48	2	10

Accessori (contropiastre, codoli, bloccaggi direzionali, parapiedi): pag 142-144

Accessories (counter-plates, stems, directional locks, footguards): page 142-144

Accessoires (contre-platines, tiges, blocages directionnels, pare-pieds): page 142-144

Zubehöre (Gegenplatten, Zapfen, Richtungsfeststeller, Fußschutz): Seite 142-144

Accesorios (contraplacas, espigas, posicionadores direccionales, guardapié): pág 142-144

ДОПОЛНИТЕЛЬНЫЕ ПРИНАДЛЕЖНОСТИ (Панели, стержни, Фиксатор направления движения, Защиты для ног): стр. 142-144

I RUOTE IN POLIURETANO ESD TR-ROLL,
NUCLEO IN ALLUMINIO

D ESD TR-ROLL POLYURETHAN-RÄDER,
ALUKERN





















GB ESD TR-ROLL POLYURETHANE WHEELS,
ALUMINIUM CENTRE





















E RUEDAS DE POLIURETANO ESD TR-ROLL,
NUCLEO DE ALUMINIO





















F ROUES EN POLYURETHANE ESD TR-ROLL,
CORPS EN ALUMINIUM

RU КОЛЕСА ИЗ ПОЛИУРЕТАНА ESD TR-ROLL,
ОСНОВАНИЕ ИЗ АЛЮМИНИЯ

62ESD

62ESD	 					 					 					 				
	COD.	 4 km/h	Euro			COD.	 4 km/h	Euro			COD.	 4 km/h	Euro			COD.	 4 km/h	Euro		
100x40	622102ESD	240	49.65	12	150	624102ESD	240	43.58	12	150	624402ESD	200	56.07	12	50	626202ESD	200	53.44	12	50
125x40	622113ESD	280	69.57	6	90	624113ESD	280	61.40	6	90	624413ESD	220	78.78	12	36	626213ESD	220	74.54	6	36
160x50	622104ESD	440	78.73	4	60	624104ESD	440	70.56	2	60	624410ESD	300	94.81	4	16	627704ESD	300	89.19	4	16
200x50	622106ESD	560	101.88	4	26	624106ESD	560	93.70	4	26	624406ESD	300	118.95	2	10	627706ESD	300	112.85	2	10

62ESD	 					 					 					 				
	COD.	 4 km/h	Euro			COD.	 4 km/h	Euro			COD.	 4 km/h	Euro			COD.	 4 km/h	Euro		
100x40	627302ESD	200	62.69	12	50															
125x40	627313ESD	220	85.41	12	36															
160x50	627304ESD	300	106.37	4	16	624504ESD	440	91.10	4	16	627704ESD	300	89.19	4	16	627404ESD	440	111.67	4	16
200x50	627306ESD	300	129.51	2	10	624506ESD	500	115.69	2	10	627706ESD	300	112.85	2	10	627406ESD	500	136.26	2	10

62ESD	 					 					 					 				
	COD.	 4 km/h	Euro			COD.	 4 km/h	Euro			COD.	 4 km/h	Euro			COD.	 4 km/h	Euro		
100x40	627602ESD	240	68.69	12	50	628512ESD	240	59.01	12	50	627202ESD	240	75.32	12	50					
125x40	627613ESD	280	89.24	12	36	628513ESD	280	79.12	12	36	627213ESD	280	95.86	12	36					
160x50	627610ESD	440	111.30	4	16	628514ESD	440	92.73	4	16						627204ESD	440	127.92	4	16
200x50	627516ESD	560	138.51	2	10	628516ESD	560	118.09	2	10						627206ESD	560	160.40	2	10

62ESD

I RUOTE IN POLIURETANO ESD TR-ROLL,
NUCLEO IN ALLUMINIO

D ESD TR-ROLL POLYURETHAN-RÄDER,
ALUKERN

GB ESD TR-ROLL POLYURETHANE WHEELS,
ALUMINIUM CENTRE

E RUEDAS DE POLIURETANO ESD TR-ROLL,
NUCLEO DE ALUMINIO

F ROUES EN POLYURETHANE ESD TR-ROLL,
CORPS EN ALUMINIUM

RU КОЛЕСА ИЗ ПОЛИУРЕТАНА ESD TR-ROLL,
ОСНОВАНИЕ ИЗ АЛЮМИНИЯ

62ESD















R \leq 10°



R \leq 10°



R \leq 10°

	 PT					 PT					 PT									
	COD.	 4 km/h	Euro			COD.	 4 km/h	Euro			COD.	 4 km/h	Euro							
160x50	625010ESD	640	114.93	4	16	628514ESD	440	92.73	4	16	629904ESD	640	131.54	4	10					
200x50	625016ESD	680	142.45	2	10	628516ESD	560	118.09	2	10	629906ESD	680	159.06	2	10					

I RUOTE IN VULKOLLAN®,
NUCLEO IN ACCIAIO FORGIATO

D VULKOLLAN®-RÄDER,
KERN AUS GESCHMIEDETEM STAHL



















GB VULKOLLAN® WHEELS,
FORGED STEEL CENTRE

















E RUEDAS DE VULKOLLAN®,
NUCLEO DE ACIERO FORJADO

















F ROUES EN VULKOLLAN®,
CORPS EN ACIER FORGE

RU КОЛЕСА ИЗ ВУЛКОЛЛАНА®,
ОСНОВАНИЕ ИЗ КОВАНОЙ СТАЛИ

63_{AC}

63 _{AC}																								
						COD.	 4 km/h	Euro			COD.	 4 km/h	Euro			COD.	 4 km/h	Euro			COD.	 4 km/h	Euro	
100x30		632122	250	57.33	12 150	634122	250	51.06	12 150	637322	200	63.97	6 50	638222	200	61.25	6 50							
125x40		632123	350	73.56	6 90	634123	350	67.66	6 90	637323	220	83.09	6 36	638223	220	78.70	6 36							
150x40 F. 17		632124	750	86.71	6 60	634124	750	80.81	6 60															
150x40 F. 20		632224	750	91.51	6 60	634224	750	82.23	6 60	637304	220	105.79	4 36	638214	220	100.79	4 36							
										637324	300	108.16	4 36	638224	300	102.33	4 36							
175x40		632125	850	114.47	4 26	634125	850	106.00	4 26	637325	300	132.15	2 16	638225	300	125.82	2 16							
200x50 F. 20		632126	1100	141.21	2 26	634126	1100	132.75	2 26	637326	300	158.88	2 10	638226	300	152.56	2 10							
200x50 F. 25		632226	1100	142.96	2 26	634226	1100	133.43	2 26															
250x60		632128	1500	208.07	1 12	634128	1500	198.53	1 12															

63 _{AC}																			
						COD.	 4 km/h	Euro			COD.	 4 km/h	Euro			COD.	 4 km/h	Euro	
150x40		637404	500	112.77	4 36	638224	500	102.33	4 36	636704	500	125.60	4 36						
200x50		637406	500	163.98	2 10	638226	500	152.56	2 10	636706	500	176.80	2 10						

63 _{AC}																			
						COD.	 4 km/h	Euro			COD.	 4 km/h	Euro			COD.	 4 km/h	Euro	
100x30		637622	250	77.05	6 50	638622	250	67.02	6 50	636302	250	83.90	6 50						
125x40		637623	350	93.92	6 36	638623	350	83.44	6 36	636303	350	100.77	6 36						

I RUOTE IN VULKOLLAN®,
NUCLEO IN ACCIAIO FORGIATO

D VULKOLLAN®-RÄDER,
KERN AUS GESCHMIEDETEN STAHL



















GB VULKOLLAN® WHEELS,
FORGED STEEL CENTRE



















E RUEDAS DE VULKOLLAN®,
NUCLEO DE ACIERO FORJADO



















F ROUES EN VULKOLLAN®,
CORPS EN ACIER FORGE



RU КОЛЕСА ИЗ ВУЛКОЛЛАНА®,
ОСНОВАНИЕ ИЗ КОВАННОЙ СТАЛИ

63_{AC}

63 _{AC}																
																
	COD.		Euro			COD.		Euro			COD.		Euro			
150x40	637624	750	125.22	4	36	638624	750	105.99	4	36	636304	750	142.42	2	36	
175x40	637625	750	152.39	2	16	638625	750	131.26	2	16	636305	750	170.30	2	16	
200x50	637626	750	179.13	2	10	638626	750	157.99	2	10	636306	750	197.04	2	10	

63 _{AC}																
																
	COD.		Euro			COD.		Euro			COD.		Euro			
150x40	635604	750	128.48	4	36	638624	750	105.99	4	36	635304	750	146.17	4	36	
175x40	635605	850	156.46	2	16	638625	850	131.26	2	16	635305	850	173.65	2	16	
200x50	635606	900	183.20	2	10	638626	900	157.99	2	10	635306	900	200.40	2	10	

63 _{AC}																
																
	COD.		Euro			COD.		Euro			COD.		Euro			
100x30	637822	250	119.46	6	50	638822	250	78.18	6	50						
125x40	637823	350	135.69	4	36	638823	350	94.41	4	36						
150x40	637824	750	183.10	4	36	638824	750	124.28	4	36	636504	750	203.16	4	36	
175x40	637825	850	208.74	2	16	638825	850	150.41	2	16	636505	850	225.93	2	16	
200x50	637826	1100	235.47	2	10	638826	1100	177.15	2	10	636506	1100	252.67	2	10	
250x60	637828	1500	360.95	1	4	638828	1500	280.96	1	4						

		GALVANISED						
	COD.	Euro						
100x30	100031	3.00						
125x40	100032	3.17						
150x40	100033	5.87						
200x50	100035	10.69						

I RUOTE IN VULKOLLAN®,
NUCLEO IN GHISA MECCANICA

D VULKOLLAN®-RÄDER,
GÜßEISENKERN



GB VULKOLLAN® WHEELS,
CAST IRON CENTRE





E RUEDAS DE VULKOLLAN®,
NUCLEO DE HIERRO FUNDIDO MECANICO

F ROUES EN VULKOLLAN®,
CORPS EN FONTE MECANIQUE

RU КОЛЕСА ИЗ ВУЛКОЛЛАНА®,
ОСНОВАНИЕ ИЗ МЕХАНИЧЕСКОГО ЧУГУНА

63GH

63GH																				
	COD.	4 km/h	Euro	■	■	COD.	4 km/h	Euro	■	■	COD.	4 km/h	Euro	■	■	COD.	4 km/h	Euro	■	■
80x28	632151	280	31.14	12	150	634151	280	25.23	12	150	634551	200	37.78	6	62	634651	200	35.07	6	62
100x38	632152	380	43.07	12	150	634152	380	36.11	12	150	634552	200	49.70	6	50	634652	200	46.99	6	50
125x38	632153	450	55.21	6	90	634153	450	48.26	6	90	634553	220	64.75	6	36	634653	220	60.35	6	36
125x50 F.20	632163	600	66.61	4	90	634163	600	58.15	4	90	634563	300	80.87	4	36	634663	300	75.89	4	36
125x50 F.25	632363	600	66.82	4	90	634163	600	58.15	4	90										
150x50 F.20	632154	700	73.17	2	60	634154	700	64.71	2	60	634554	300	89.82	4	36	634654	300	83.99	4	36
150x50 F.25	632354	700	73.39	6	60	634154	700	64.71	2	60										
160x50 F.20	632164	750	90.05	2	60	634164	750	81.59	2	60	634564	300	106.70	4	16	634664	300	100.87	4	16
160x50 F.25	632364	750	90.26	4	60	634164	750	81.59	2	60										
180x50	632155	900	91.55	2	26	634155	900	83.08	2	26	634555	300	109.22	2	16	634655	300	102.90	2	16
200x50 F.20	632156	1000	113.02	2	26	634156	1000	104.57	2	26	634556	300	130.70	2	10	634656	300	124.38	2	10
200x50 F.25	632356	1000	113.24	2	26	634156	1000	104.57	2	26										
200x80 F.25	632166	1600	163.08	1	26	634166	1600	150.94	1	26										
200x80 F.30	632366	1600	163.41	1	26	634166	1600	150.94	1	26										
250x60 F.25	632157	1500	166.51	1	12	634157	1500	154.37	1	12										
250x60 F.30	632357	1500	166.83	1	12	634157	1500	154.37	1	12										
250x80 F.25	632167	1900	211.30	1	12	634167	1900	199.17	1	12										
250x80 F.30	632367	1900	211.62	1	12	634167	1900	199.17	1	12										
300x60	632158	1750	246.10	1	6	634158	1750	233.64	1	6										
300x80	632168	2300	297.27	1	6	634168	2300	284.82	1	6										

63GH																					
	COD.	4 km/h	Euro	■	■	COD.	4 km/h	Euro	■	■	COD.	4 km/h	Euro	■	■	COD.	4 km/h	Euro	■	■	
80x28	635451	200	44.64	6	62																
100x38	635452	200	56.56	6	50																
125x38	635453	220	71.60	6	36																
125x50	635463	300	87.74	4	36																
150x50						637424	500	94.44	4	36	634654	500	83.99	4	36	636724	500	107.26	4	36	
160x50	635474	300	117.62	4	16	637434	500	111.31	4	16	634664	500	100.87	4	16	636734	500	124.14	4	16	
180x50	635465	300	120.15	2	16																
200x50	635466	300	141.63	2	10	637426	500	135.79	2	10	634656	500	124.38	2	10	636726	500	148.62	2	10	

I RUOTE IN VULKOLLAN®,
NUCLEO IN GHISA MECCANICA

D VULKOLLAN®-RÄDER,
GUßEISENKERN

GB VULKOLLAN® WHEELS,
CAST IRON CENTRE

E RUEDAS DE VULKOLLAN®,
NUCLEO DE HIERRO FUNDIDO MECANICO

F ROUES EN VULKOLLAN®,
CORPS EN FONTE MECANIQUE

RU КОЛЕСА ИЗ ВУЛКОЛЛАНА®,
ОСНОВАНИЕ ИЗ МЕХАНИЧЕСКОГО ЧУГУНА

63GH

63GH



COD.	4 km/h	Euro	P		COD.	4 km/h	Euro	P		COD.	4 km/h	Euro	P	
			■	■				■	■				■	■
80x28	635851	280	50.85	6 62	636851	280	40.82	6 62						
100x38	635852	350	62.77	6 50	636852	350	52.74	6 50	634852	350	69.63	6 50		
125x38	635853	350	75.57	6 36	636853	350	65.09	6 36	634853	350	82.42	6 36		

63GH



COD.	4 km/h	Euro	P		COD.	4 km/h	Euro	P		COD.	4 km/h	Euro	P	
			■	■				■	■				■	■
125x50	635863	550	95.25	4 36	636863	550	78.47	4 36	634863	550	112.44	4 36		
150x50	635854	700	106.88	4 36	636854	700	87.65	4 36	634854	700	124.08	4 36		
160x50	635864	750	123.75	4 16	636864	750	104.54	4 16	634864	750	140.96	4 16		
180x50	635855	750	129.47	2 16	636855	750	108.33	2 16	634855	750	146.66	2 16		
200x50	635856	750	150.94	2 10	636856	750	129.81	2 10	634856	750	167.71	2 10		

63GH



COD.	4 km/h	Euro	PT		COD.	4 km/h	Euro	PT		COD.	4 km/h	Euro	PT	
			■	■				■	■				■	■
125x50	635003	600	100.91	4 36	636863	550	78.47	4 36	639903	550	118.10	4 36		
150x50	635004	700	110.63	4 36	636854	700	87.65	4 36	639904	700	127.83	4 36		
160x50	635014	750	127.51	4 16	636864	750	104.54	4 16	639914	750	144.70	4 16		
180x50	635005	900	133.54	2 16	636855	900	108.33	2 16	639905	900	150.73	2 16		
200x50	635006	900	155.01	2 10	636856	900	129.81	2 10	639906	900	172.21	2 10		

I RUOTE IN VULKOLLAN®,
NUCLEO IN GHISA MECCANICA

D VULKOLLAN®-RÄDER,
GÜßEISENKERN







GB VULKOLLAN® WHEELS,
CAST IRON CENTRE







E RUEDAS DE VULKOLLAN®,
NUCLEO DE HIERRO FUNDIDO MECANICO







F ROUES EN VULKOLLAN®,
CORPS EN FONTE MECANIQUE

RU КОЛЕСА ИЗ ВУЛКОЛЛАНА®,
ОСНОВАНИЕ ИЗ МЕХАНИЧЕСКОГО ЧУГУНА

63GH

63GH															
			EP				EP				EP				
	COD.	4 km/h	Euro	■	■	COD.	4 km/h	Euro	■	■	COD.	4 km/h	Euro	■	■
100x38	637852	350	105.20	4	50	638852	350	63.92	4	50					
125x38	637853	350	117.34	4	36	638853	350	76.07	4	36					
150x50	637854	700	164.76	2	36	638854	700	105.94	2	36	636654	700	181.96	2	36
160x50	637864	750	181.63	2	16	638864	750	122.81	2	16	636664	750	198.83	2	16
180x50	637855	900	185.81	1	16	638855	900	127.49	1	16	636655	900	203.00	1	16
200x50	637856	1000	207.29	1	10	638856	1000	148.97	1	10	636656	1000	224.48	1	10
200x80	637866	1600	315.96	1	10	638866	1600	235.98	1	10					
250x60	637857	1500	319.40	1	4	638857	1500	239.41	1	4					

63GH															
			EE MHD				EE MHD				EE MHD				
	COD.	4 km/h	Euro	■	■	COD.	4 km/h	Euro	■	■	COD.	4 km/h	Euro	■	■
125x50	638303	600	151.95	2	36	638403	600	107.71	2	36	638903	600	183.95	2	36
150x50	638304	700	158.52	2	36	638404	700	114.27	2	36	638904	700	190.51	2	36
160x50	638314	750	175.39	2	16	638414	750	131.16	2	16	638914	750	207.39	2	16
180x50	638305	900	176.89	2	16	638405	900	132.65	2	16	638905	900	208.89	1	16
200x50	638306	1000	198.37	1	10	638406	1000	154.13	1	10	638906	1000	230.37	1	10

63GH															
			EE HD				EE HD				EE HD				
	COD.	4 km/h	Euro	■	■	COD.	4 km/h	Euro	■	■	COD.	4 km/h	Euro	■	■
200x80	638316	1600	308.37	1	10	638416	1600	231.34	1	10	638916	1600	340.36	1	10
250x60	638307	1500	311.79	1	4	638407	1500	234.77	1	4	638907	1500	343.79	1	4
250x80	638317	1600	356.58	1	4	638417	1600	279.55	1	4	638917	1600	388.58	1	4
250x80 PG	638327	1900	379.00	1	4	638427	1900	297.53	1	4	638927	1900	411.00	1	4
300x60	638308	1600	421.23	1	2	638408	1600	326.04	1	2	638908	1600	453.24	1	2
300x60 PG	638328	1750	450.36	1	2	638428	1750	338.23	1	2	638928	1750	482.36	1	2
300x80	638318	1600	472.42	1	2	638418	1600	377.21	1	2	638918	1600	504.41	1	2
300x80 PG	638338	2300	501.54	1	2	638438	2300	389.40	1	2	638938	2300	533.53	1	2

I RUOTE IN VULKOLLAN®,
NUCLEO IN GHISA MECCANICA

D VULKOLLAN®-RÄDER,
GÜßEISENKERN

GB VULKOLLAN® WHEELS,
CAST IRON CENTRE

E RUEDAS DE VULKOLLAN®,
NUCLEO DE HIERRO FUNDIDO MECANICO

F ROUES EN VULKOLLAN®,
CORPS EN FONTE MECANIQUE

RU КОЛЕСА ИЗ ВУЛКОЛЛАНА®,
ОСНОВАНИЕ ИЗ МЕХАНИЧЕСКОГО ЧУГУНА

63GH

63GH



COD.	4 km/h	Euro	EEG MHD		COD.	4 km/h	Euro	EEG MHD		COD.	4 km/h	Euro	EEG HD		COD.	4 km/h	Euro	EEG HD		
			■	■				■	■				■	■				■	■	
100x(38+38)	638062	700	190.49	2	50	638162	700	143.22	2	50										
125x(38+38)	638063	900	227.53	2	36	638163	900	173.91	2	36										
125x(50+50)											638072	1200	376.25	2	36	638172	1200	236.46	2	36
150x(50+50)											638074	1400	389.39	1	36	638174	1400	249.58	1	36
160x(50+50)											638084	1500	423.14	1	16	638184	1500	283.33	1	16
200x(50+50)											638066	1600	469.09	1	10	638166	1600	329.29	1	10
200x(50+50)PG											638076	2000	481.80	1	10	638176	2000	342.00	1	10

63GH



COD.	4 km/h	Euro	EEG EHD		COD.	4 km/h	Euro	EEG EHD		
			■	■				■	■	
200x(80+80)	638086	3200	751.33	1	10	638186	3200	522.55	1	10
250x(60+60)	638067	3000	758.18	1	4	638167	3000	529.41	1	4
250x(80+80)	638077	3500	878.69	1	4	638177	3500	642.16	1	4

63GH



COD.	4 km/h	Euro	EES MHD		COD.	4 km/h	Euro	EES MHD		COD.	4 km/h	Euro	EES MHD		
			■	■				■	■						
160x50	639304	750	301.61	2	16	639404	750	257.16	2	16	639504	750	344.46	2	16
200x50	639306	1000	324.60	1	10	639406	1000	280.13	1	10	639506	1000	370.18	1	10

Accessori (contropiastre, codoli, bloccaggi direzionali, parapiedi) : pag 142-144

Accessories (counter-plates, stems, directional locks, footguards): page 142-144

Accessoires (contre-platines, tiges, blocages directionnels, pare-pieds): page 142-144

Zubehöre (Gegenplatten, Zapfen, Richtungsfeststeller, Fußschutz): Seite 142-144

Accesorios (contraplacas, espigas, posicionadores direccionales, guardapié): pág 142-144

ДОПОЛНИТЕЛЬНЫЕ ПРИНАДЛЕЖНОСТИ (Панели, стержни, Фиксатор направления движения, Защиты для ног): стр. 142-144

I RUOTE IN POLIURETANO TR,
NUCLEO IN GHISA MECCANICA

D TR POLYURETHAN-RÄDER,
GÜßEISENKERN

GB TR POLYURETHANE WHEELS,
CAST IRON CENTRE

E RUEDAS DE POLIURETANO TR,
NUCLEO DE HIERRO FUNDIDO MECANICO

F ROUES EN POLYURETHANE TR,
CORPS EN FONTE MECANIQUE

RU КОЛЕСА ИЗ ПОЛИУРЕТАНА TR,
ОСНОВАНИЕ ИЗ МЕХАНИЧЕСКОГО ЧУГУНА

64



KEY HOUSING

	[Red Key Housing]					[Red Key Housing]												
	COD.	4 km/h	Euro			COD.	4 km/h	Euro										
100x40 15H7	641102	300	24.04	8	150	641202	300	49.92	8	150								
125x40 20H7	641103	400	27.33	4	90	641203	400	53.21	4	90								
150x40 20H7	641104	500	38.01	4	60	641204	500	63.88	4	60								
150x50 20H7	641114	700	44.41	4	60	641214	700	70.29	4	60								
180x50 20H7	641105	800	54.23	2	26	641205	800	80.11	2	26								
200x50 20H7	641106	950	59.74	2	26	641206	950	85.62	2	26								
200x60 25H7	641116	1000	83.23	2	26	641216	1000	109.11	2	26								
200x80 40H7	641126	1400	113.31	1	26	641226	1400	154.71	1	26								
250x50 20H7	641107	1100	90.03	1	12	641207	1100	115.91	1	12								
250x80 40H7	641117	1600	137.99	1	12	641217	1600	179.39	1	12								
250x80 60H7	641127	1600	137.99	1	12	641227	1600	179.39	1	12								
300x80 50H7	641108	2000	179.43	1	6	641208	2000	257.05	1	6								
300x100 50H7	641118	2500	236.26	1	6	641218	2500	313.88	1	6								
350x100 50H7	641109	2800	309.09	1	4	641209	2800	391.89	1	4								
400x100 50H7	641110	3500	354.75	1	2	641210	3500	437.53	1	2								

I RUOTE IN POLIURETANO TR,
NUCLEO IN GHISA MECCANICA

D TR POLYURETHAN-RÄDER,
GÜßEISENKERN

GB TR POLYURETHANE WHEELS,
CAST IRON CENTRE

E RUEDAS DE POLIURETANO TR,
NUCLEO DE HIERRO FUNDIDO MECANICO

F ROUES EN POLYURETHANE TR,
CORPS EN FONTE MECANIQUE

RU КОЛЕСА ИЗ ПОЛИУРЕТАНА TR,
ОСНОВАНИЕ ИЗ МЕХАНИЧЕСКОГО ЧУГУНА



64



	COD.	4 km/h	Euro	■	■	COD.	4 km/h	Euro	■	■	COD.	4 km/h	Euro	■	■	COD.	4 km/h	Euro	■	■
80x20	642181	150	17.97	12	150	644181	150	11.90	12	150						644651	200	23.14	6	62
80x28	642151	280	19.35	12	150	644151	280	13.65	12	150	644551	200	25.77	6	62	644651	200	23.14	6	62
100x38	642152	380	26.26	12	150	644152	380	19.54	12	150	644552	200	32.67	6	50	644652	200	30.05	6	50
125x38	642153	450	33.68	6	90	644153	450	26.96	6	90	644553	220	42.89	6	36	644653	220	38.65	6	36
125x50 F.20	642163	550	40.24	4	90	644163	550	32.06	4	90	644563	300	54.03	4	36	644663	300	49.20	4	36
125x50 F.25	642363	550	40.45	4	90	644163	550	32.06	4	90										
125x58	642103	600	67.16	4	90	644103	600	58.98	4	90										
150x50 F.20	642154	700	44.64	2	60	644154	700	36.46	2	60	644554	300	60.72	4	36	644654	300	55.09	4	36
150x50 F.25	642354	700	44.85	2	60	644154	700	36.46	2	60										
150x58	642104	850	77.81	2	60	644104	850	69.63	2	60										
150x78	642124	1000	103.16	2	60	644124	1000	91.43	2	60										
160x50 F.20	642164	750	56.01	2	60	644164	750	47.84	2	60	644564	300	72.10	4	16	644664	300	66.47	4	16
160x50 F.25	642364	750	56.22	2	60	644164	750	47.84	2	60										
180x50	642155	900	57.28	2	26	644155	900	49.10	2	26	644555	300	74.35	2	16	644655	300	68.25	2	16
200x50 F.20	642156	1000	68.95	2	26	644156	1000	60.78	2	26	644556	300	86.03	2	10	644656	300	79.92	2	10
200x50 F.25	642356	1000	69.88	2	26	644156	1000	60.78	2	26										
200x78 F.25	642166	1600	99.53	1	26	644166	1600	87.80	1	26										
200x78 F.30	642366	1600	99.84	1	26	644166	1600	87.80	1	26										
250x50	642147	1200	102.26	1	12	644147	1200	93.25	1	12										
250x60 F.25	642157	1500	103.57	1	12	644157	1500	91.85	1	12										
250x60 F.30	642357	1500	103.88	1	12	644157	1500	91.85	1	12										
250x78 F.25	642167	1900	131.42	1	12	644167	1900	119.70	1	12										
250x78 F.30	642367	1900	131.81	1	12	644167	1900	119.70	1	12										
300x60	642158	1750	150.13	1	6	644158	1750	138.09	1	6										
300x78	642168	2300	181.36	1	6	644168	2300	169.33	1	6										
300x100	642178	2500	259.37	1	4	644178	2500	222.65	1	4										
360x120	642139	2800	541.59	1	4	644139	2800	499.68	1	4										
400x100	642129	2800	431.14	1	2	644129	2800	394.42	1	2										

I RUOTE IN POLIURETANO TR,
NUCLEO IN GHISA MECCANICA

D TR POLYURETHAN-RÄDER,
GUßEISENKERN

GB TR POLYURETHANE WHEELS,
CAST IRON CENTRE

E RUEDAS DE POLIURETANO TR,
NUCLEO DE HIERRO FUNDIDO MECANICO

F ROUES EN POLYURETHANE TR,
CORPS EN FONTE MECANIQUE

RU КОЛЕСА ИЗ ПОЛИУРЕТАНА TR,
ОСНОВАНИЕ ИЗ МЕХАНИЧЕСКОГО ЧУГУНА

64



COD.	4 km/h	Euro	NL		COD.	4 km/h	Euro	M		COD.	4 km/h	Euro	M		COD.	4 km/h	Euro	M	
			⚙️	⚙️				⚙️	⚙️				⚙️	⚙️				⚙️	⚙️

80x28	645451	200	32.40	6	62															
100x38	645452	200	39.30	6	50															
125x38	645453	220	49.51	6	36															
125x50	645463	300	60.65	4	36															
150x50	645464	300	71.28	4	36	644954	500	65.18	4	36	644654	500	55.09	4	36	645564	500	77.57	4	36
160x50	645474	300	82.66	4	16	644964	500	76.56	4	16	644664	500	66.47	4	16	645574	500	88.95	4	16
180x50	645465	300	84.91	2	16															
200x50	645466	300	96.59	2	10	644956	500	90.95	2	10	644656	500	79.92	2	10	645566	500	103.33	2	10

64



COD.	4 km/h	Euro	P		COD.	4 km/h	Euro	P		COD.	4 km/h	Euro	P	
			⚙️	⚙️				⚙️	⚙️					

80x28	645851	280	38.40	6	62	646851	280	28.71	6	62					
100x38	645852	350	45.30	6	50	646852	350	35.61	6	50	644852	350	51.93	6	50
125x38	645853	350	53.34	6	36	646853	350	43.22	6	36	644853	350	59.97	6	36

64



COD.	4 km/h	Euro	P		COD.	4 km/h	Euro	P		COD.	4 km/h	Euro	P	
			⚙️	⚙️				⚙️	⚙️					

125x50	645863	550	67.92	4	36	646863	550	51.71	4	36	644863	550	84.53	2	36
150x50	645854	700	77.21	2	36	646854	700	58.63	2	36	644854	700	93.82	2	36
160x50	645864	750	88.59	2	16	646864	750	70.01	2	16	644864	750	105.20	2	16
180x50	645855	750	93.92	2	16	646855	750	73.50	2	16	644855	750	110.53	2	16
200x50	645856	750	105.59	2	10	646856	750	85.17	2	10	644856	750	122.90	2	10

I RUOTE IN POLIURETANO TR,
NUCLEO IN GHISA MECCANICA

D TR POLYURETHAN-RÄDER,
GUßEISENKERN

GB TR POLYURETHANE WHEELS,
CAST IRON CENTRE

E RUEDAS DE POLIURETANO TR,
NUCLEO DE HIERRO FUNDIDO MECANICO

F ROUES EN POLYURETHANE TR,
CORPS EN FONTE MECANIQUE

RU КОЛЕСА ИЗ ПОЛИУРЕТАНА TR,
ОСНОВАНИЕ ИЗ МЕХАНИЧЕСКОГО ЧУГУНА

64

64



	PT					PT					PT				
	COD.	4 km/h	Euro	■	■	COD.	4 km/h	Euro	■	■	COD.	4 km/h	Euro	■	■
125x50	645003	550	71.54	4	36	646863	550	51.71	4	36	649903	550	88.15	4	36
150x50	645004	700	80.83	4	36	646854	700	58.63	4	36	649904	700	97.45	4	36
160x50	645014	750	92.21	4	16	646864	750	70.01	4	16	649914	750	108.82	4	16
180x50	645005	900	97.85	2	16	646855	900	73.50	2	16	649905	900	114.46	2	16
200x50	645006	900	109.52	2	10	646856	900	85.17	2	10	649906	900	126.14	2	10

64



	EP					EP					EP				
	COD.	4 km/h	Euro	■	■	COD.	4 km/h	Euro	■	■	COD.	4 km/h	Euro	■	■
100x38	647852	350	86.29	4	50	648852	350	46.41	4	50					
125x38	647853	350	93.71	4	36	648853	350	53.83	4	36					
125x50	647863	550	128.73	2	36	648863	550	71.90	2	36					
150x50	647854	700	133.13	2	36	648854	700	76.30	2	36	646654	700	149.74	2	36
150x58	647824	850	166.30	2	36	648824	850	109.47	2	36					
160x50	647864	750	144.51	2	16	648864	750	87.67	2	16	646664	750	161.12	2	16
180x50	647855	900	148.36	1	16	648855	900	92.00	1	16	646655	900	164.97	1	16
200x50	647856	1000	160.03	1	10	648856	1000	103.68	1	10	646656	1000	176.64	1	10
200x78	647866	1600	247.24	1	10	648866	1600	169.96	1	10					
250x60	647857	1500	251.29	1	4	648857	1500	174.00	1	4					

64



	EE MHD					EE MHD					EE MHD				
	COD.	4 km/h	Euro	■	■	COD.	4 km/h	Euro	■	■	COD.	4 km/h	Euro	■	■
125x50	648303	550	122.70	2	36	648403	550	79.95	2	36	648503	550	153.61	2	36
150x50	648304	700	127.10	2	36	648404	700	84.35	2	36	648504	700	158.01	2	36
160x50	648314	750	138.47	2	16	648414	750	95.73	2	16	648514	750	169.39	2	16
180x50	648305	900	139.74	2	16	648405	900	96.99	2	16	648505	900	170.65	1	16
200x50	648306	1000	151.41	1	10	648406	1000	108.66	1	10	648506	1000	182.33	1	10

I RUOTE IN POLIURETANO TR,
NUCLEO IN GHISA MECCANICA

D TR POLYURETHAN-RÄDER,
GUßEISENKERN



















GB TR POLYURETHANE WHEELS,
CAST IRON CENTRE













E RUEDAS DE POLIURETANO TR,
NUCLEO DE HIERRO FUNDIDO MECANICO

F ROUES EN POLYURETHANE TR,
CORPS EN FONTE MECANIQUE

RU КОЛЕСА ИЗ ПОЛИУРЕТАНА TR,
ОСНОВАНИЕ ИЗ МЕХАНИЧЕСКОГО ЧУГУНА

64

64															
				EE HD				EE HD				EE HD			
	COD.	 4 km/h	Euro			COD.	 4 km/h	Euro			COD.	 4 km/h	Euro		
150x78	648315	1000	243.53	1	36	648415	1000	169.11	1	36	648515	1000	274.44	1	36
150x78 PG	648324	1000	265.19	1	36	648424	1000	186.48	2	36					
200x78	648316	1600	239.89	1	10	648416	1600	165.48	1	10	648516	1600	270.81	1	10
250x60	648307	1500	243.94	1	4	648407	1500	169.52	1	4	648507	1500	274.85	1	4
250x78	648317	1600	271.79	1	4	648417	1600	197.37	1	4	648517	1600	302.71	1	4
250x78 PG	648327	1900	293.45	1	4	648427	1900	214.74	1	4	648527	1900	324.37	1	4
300x60	648308	1600	319.34	1	2	648408	1600	227.36	1	2	648508	1600	350.25	1	2
300x60 PG	648328	1750	347.48	1	2	648428	1750	239.14	1	2	648528	1750	378.40	1	2
300x78	648318	1600	350.58	1	2	648418	1600	258.59	1	2	648518	1600	381.49	1	2
300x78 PG	648338	2300	378.72	1	2	648438	2300	270.37	1	2	648538	2300	409.63	1	2

64										
				EE EHD				EE EHD		
	COD.	 4 km/h	Euro			COD.	 4 km/h	Euro		
300x100	648309	2500	638.08	1	2	648409	2500	421.56	1	2
400x100	648310	2800	834.16	1	2	648410	2800	609.64	1	2

I RUOTE IN POLIURETANO TR,
NUCLEO IN GHISA MECCANICA

D TR POLYURETHAN-RÄDER,
GÜßEISENKERN





GB TR POLYURETHANE WHEELS,
CAST IRON CENTRE



E RUEDAS DE POLIURETANO TR,
NUCLEO DE HIERRO FUNDIDO MECANICO



F ROUES EN POLYURETHANE TR,
CORPS EN FONTE MECANIQUE

RU КОЛЕСА ИЗ ПОЛИУРЕТАНА TR,
ОСНОВАНИЕ ИЗ МЕХАНИЧЕСКОГО ЧУГУНА

64

64																						
	EEG MHD		EEG MHD		EEG MHD		EEG HD		EEG HD		EEG HD		EEG HD		EEG HD		EEG HD					
	COD.	4 km/h	Euro	■	■	COD.	4 km/h	Euro	■	■	COD.	4 km/h	Euro	■	■	COD.	4 km/h	Euro	■	■		
100x(38+38)	648062	700	153.36	2	50	648162	700	107.68	2	50												
125x(38+38)	648063	900	180.51	2	36	648163	900	128.70	2	36												
125x(50+50)											648072	1100	315.30	2	36	648172	1100	180.22	1	36		
150x(50+50)											648074	1400	324.10	1	36	648174	1400	189.02	1	36		
160x(50+50)											648084	1500	346.85	1	16	648184	1500	211.77	1	16		
200x(50+50)											648066	1600	374.17	1	10	648166	1600	239.10	1	10		
200x(50+50)PG											648076	2000	386.46	1	10	648176	2000	251.38	1	10		

64																									
	EEG EHD		EEG EHD		EEG EHD		EEG EHD		EEG EHD		EEG EHD		EEG EHD		EEG EHD		EEG EHD		EEG EHD		EEG EHD				
	COD.	4 km/h	Euro	■	■	COD.	4 km/h	Euro	■	■	COD.	4 km/h	Euro	■	■	COD.	4 km/h	Euro	■	■	COD.	4 km/h	Euro	■	■
200x(78+78)	648086	3200	609.83	1	10	648186	3200	388.80	1	10															
250x(60+60)	648067	3000	617.93	1	4	648167	3000	396.89	1	4															
250x(78+78)	648077	3500	673.77	1	4	648177	3500	452.74	1	4															
300x(78+78)	648078	4300	802.78	1	2	648178	4300	574.24	1	2															

64																									
	EES MHD		EES MHD		EES MHD		EES MHD		EES MHD		EES MHD		EES MHD		EES MHD		EES MHD		EES MHD		EES MHD				
	COD.	4 km/h	Euro	■	■	COD.	4 km/h	Euro	■	■	COD.	4 km/h	Euro	■	■	COD.	4 km/h	Euro	■	■	COD.	4 km/h	Euro	■	■
160x50	649304	750	260.43	2	16	649404	750	217.47	2	16	649504	750	301.83	2	16										
200x50	649306	1000	273.36	1	10	649406	1000	230.41	1	10	649506	1000	314.76	1	10										
250x50	649308	1000	363.08	1	8	649408	1000	287.52	1	8	649508	1000	404.48	1	8										

Accessori (contropiastre, codoli, bloccaggi direzionali, parapiedi) : pag 142-144

Accessories (counter-plates, stems, directional locks, footguards): page 142-144

Accessoires (contre-platines, tiges, blocages directionnels, pare-pieds): page 142-144

Zubehöre (Gegenplatten, Zapfen, Richtungsfeststeller, Fußschutz): Seite 142-144

Accesorios (contraplacas, espigas, posicionadores direccionales, guardapié): pág 142-144

ДОПОЛНИТЕЛЬНЫЕ ПРИНАДЛЕЖНОСТИ (Панели, стержни, Фиксатор направления движения, Защиты для ног): стр. 142-144

I RUOTE IN POLIURETANO TR,
NUCLEO IN ALLUMINIO

D TR POLYURETHAN-RÄDER,
ALUKERN

GB TR POLYURETHANE WHEELS,
ALUMINIUM CENTRE

E RUEDAS DE POLIURETANO TR,
NUCLEO DE ALUMINIO

F ROUES EN POLYURETHANE TR,
CORPS EN ALUMINIUM

RU КОЛЕСА ИЗ ПОЛИУРЕТАНА TR,
ОСНОВАНИЕ ИЗ АЛЮМИНИЯ

65_{AL}

65_{AL}



COD.	4 km/h	Euro	NL		COD.	4 km/h	Euro	NL		COD.	4 km/h	Euro	NL		COD.	4 km/h	Euro	NL		
			■	■				■	■				■	■				■	■	■
80x25	652101	220	14.96	12	150	654101	220	9.25	12	150	659301	200	21.37	12	62	658201	200	18.74	6	62
100x30	652102	250	22.20	12	150	654102	250	16.14	12	150	659302	200	28.62	12	50	658202	200	25.99	6	50
125x35	652103	400	23.82	6	90	654103	400	17.75	6	90	659303	220	33.03	12	36	658203	220	28.78	6	36
150x40 B	651104	600	31.82	4	60	653104	600	23.64	4	60	659312	220	45.60	4	36	658112	220	40.78	4	36
150x40											659304	300	47.90	4	36	658104	300	42.27	4	36
160x50	652114	800	37.88	4	60	654114	800	29.70	4	60	659514	300	53.96	4	16	658114	300	48.33	4	16
200x50 F. 20	651106	850	50.66	4	26	653106	850	41.66	4	26	659306	300	67.74	2	10	658106	300	61.63	2	10
200x50 F. 25	651206	850	50.87	4	26	653106	850	41.66	4	26										

65_{AL}



COD.	4 km/h	Euro	NL		COD.	4 km/h	Euro	NL		COD.	4 km/h	Euro	NL		COD.	4 km/h	Euro	NL		
			■	■				■	■				■	■				■	■	
80x25	656501	200	28.00	12	62	656401	200	21.37	12	62	656801	200	28.00	12	62					
100x30	656502	200	35.24	12	50	656402	200	28.62	12	50	656802	200	35.24	12	50					
125x35	656503	220	39.65	12	36	656403	220	33.03	6	36	656803	220	39.65	6	36					
150x40	656504	300	58.46	4	36	656404	300	47.90	4	36	656804	300	58.46	4	36					
160x50	656514	300	64.52	4	16	656414	300	53.96	4	16	656814	300	64.52	4	16	654804	300	68.66	4	16
200x50	656506	300	78.30	2	10	656406	300	67.74	2	10	656806	300	78.30	2	10	654806	300	82.44	2	10

65_{AL}



COD.	4 km/h	Euro	NL		COD.	4 km/h	Euro	M		COD.	4 km/h	Euro	M		COD.	4 km/h	Euro	M		
			■	■				■	■				■	■				■	■	
150x40					659604	500	52.36	4	36	658104	500	42.27	4	36	659704	500	64.75	4	36	
160x50	654710	300	68.66	4	16	659614	500	58.43	4	16	658114	500	48.33	4	16	659714	500	70.81	4	16
200x50	654716	300	82.44	2	10	659606	500	72.66	2	10	658106	500	61.63	2	10	659706	500	85.05	2	10

I RUOTE IN POLIURETANO TR,
NUCLEO IN ALLUMINIO

D TR POLYURETHAN-RÄDER,
ALUKERN

GB TR POLYURETHANE WHEELS,
ALUMINIUM CENTRE

E RUEDAS DE POLIURETANO TR,
NUCLEO DE ALUMINIO

















F ROUES EN POLYURETHANE TR,
CORPS EN ALUMINIUM

RU КОЛЕСА ИЗ ПОЛИУРЕТАНА TR,
ОСНОВАНИЕ ИЗ АЛЮМИНИЯ

65_{AL}

















65_{AL}



	 					 					 				
	COD.	 4 km/h	Euro			COD.	 4 km/h	Euro			COD.	 4 km/h	Euro		
100x30	657602	250	41.24	12	50	658602	250	31.56	6	50	656602	250	47.87	12	50
125x35	657603	350	43.48	12	36	658603	350	33.36	6	36	656603	350	50.10	4	36

















65_{AL}



	 					 					 				
	COD.	 4 km/h	Euro			COD.	 4 km/h	Euro			COD.	 4 km/h	Euro		
150x40	657604	600	64.39	4	36	658604	600	45.81	4	36	656604	600	81.00	4	36
160x50	657514	750	70.45	4	16	658614	750	51.87	4	16	656614	750	87.06	4	16
200x50	657606	750	87.30	2	10	658606	750	66.88	2	10	656606	750	103.91	2	10

65_{AL}



	 					 					 				
	COD.	 4 km/h	Euro			COD.	 4 km/h	Euro			COD.	 4 km/h	Euro		
150x40	657544	600	68.01	4	36	658604	600	45.81	4	36	656674	600	84.62	4	36
160x50	657554	800	74.07	4	16	658614	800	51.87	4	16	656684	800	90.69	4	16
200x50	657546	850	91.24	2	10	658606	850	66.88	2	10	656676	850	107.85	2	10

I RUOTE IN POLIURETANO TR,
NUCLEO IN ALLUMINIO

D TR POLYURETHAN-RÄDER,
ALUKERN

GB TR POLYURETHANE WHEELS,
ALUMINIUM CENTRE

E RUEDAS DE POLIURETANO TR,
NUCLEO DE ALUMINIO

F ROUES EN POLYURETHANE TR,
CORPS EN ALUMINIUM

RU КОЛЕСА ИЗ ПОЛИУРЕТАНА TR,
ОСНОВАНИЕ ИЗ АЛЮМИНИЯ



	COD.	4 km/h	Euro	■	■	COD.	4 km/h	Euro	■	■	COD.	4 km/h	Euro	■	■
100x30	657802	250	82.23	12	50	658802	250	42.35	6	50					
125x35	657803	350	83.85	6	36	658803	350	43.97	6	36					
150x40	657704	600	120.31	4	36	658704	600	63.48	4	36	656904	600	136.92	4	36
160x50	657714	800	126.37	4	16	658714	800	69.54	4	16	657014	800	142.99	4	16
200x50	657706	850	141.74	2	10	658706	850	85.39	2	10	656906	850	158.36	2	10

	GALVANISED															
	COD.	Euro														
80x25	100461	2.02														
100x30	100462	2.20														
125x35	100463	2.37														
150x40	100464	2.52														
200x50	100466	2.94														

Per ordinare ruote e supporti montati con parafili, indicare il suffisso PF dopo il codice del complessivo ruota e supporto
 To order castors fitted with threadguards, please add "PF" to the complete unit code
 Pour commander les roues et roulettes avec pare-fils montés on doit indiquer après le code de la référence le suffixe "PF"
 Falls ein Fadenschutz gewünscht wird, bitte der Artikel-Nr. die Abkürzung "PF" hinzufügen
 Para solicitar un artículo con placa anti-hilos se necesita la sigla PF después del código del artículo de la rueda con soporte
 Чтобы заказать колеса и опоры с нитезащитным устройством, необходимо указать аббревиатуру PF после кода узла колесо + опора.

Accessori (contropiastre, codoli, bloccaggi direzionali, parapiedi) : pag 142-144
 Accessories (counter-plates, stems, directional locks, footguards): page 142-144
 Accessoires (contre-platines, tiges, blocages directionnels, pare-pieds): page 142-144
 Zubehör (Gegenplatten, Zapfen, Richtungsfeststeller, Fußschutz): Seite 142-144
 Accesorios (contraplacas, espigas, posicionadores direccionales, guardapié): pag 142-144
 ДОПОЛНИТЕЛЬНЫЕ ПРИНАДЛЕЖНОСТИ (Панели, стержни, Фиксатор направления движения, Защиты для ног): стр. 142-144

I RUOTE IN POLIURETANO TR,
NUCLEO IN GHISA MECCANICA

D TR POLYURETHAN-RÄDER,
GUßEISENKERN



















GB TR POLYURETHANE WHEELS,
CAST IRON CENTRE



















E RUEDAS DE POLIURETANO TR,
NUCLEO DE HIERRO FUNDIDO MECANICO



















F ROUES EN POLYURETHANE TR,
CORPS EN FONTE MECANIQUE

RU КОЛЕСА ИЗ ПОЛИУРЕТАНА TR,
ОСНОВАНИЕ ИЗ МЕХАНИЧЕСКОГО ЧУГУНА

65GH

65GH																				
																				
	COD.	4 km/h	Euro	■	■	COD.	4 km/h	Euro	■	■	COD.	4 km/h	Euro	■	■	COD.	4 km/h	Euro	■	■
150x30	652104	400	42.40	6	60	654104	400	36.70	6	60	656204	300	58.49	4	36	658204	300	52.86	4	36
150x35	652224	490	45.99	6	60	654224	490	37.81	6	60	656214	300	62.07	4	36	658214	300	56.44	4	36
175x35	652105	650	54.20	4	26	654105	650	46.03	4	26	656205	300	71.28	4	16	658205	300	65.17	4	16
200x45 F.20	652106	1000	68.53	4	26	654106	1000	60.35	4	26	656206	300	85.60	2	10	658206	300	79.50	2	10
200x45 F.25	652206	1000	72.53	4	26	654206	1000	63.32	4	26										
250x50 F. 20	652208	1200	98.75	2	26	654108	1200	89.74	1	12										
250x50 F. 25	652108	1200	98.96	2	12	654108	1200	89.74	1	12										
300x70	652109	2200	191.83	1	6	654109	2200	179.79	1	6										

65GH															
															
	COD.	4 km/h	Euro	■	■	COD.	4 km/h	Euro	■	■	COD.	4 km/h	Euro	■	■
150x30	656524	300	69.04	4	36	656424	300	58.49	4	36	656824	300	69.04	4	36
150x35	656534	300	72.63	4	36	656434	300	62.07	4	36	656834	300	72.63	4	36
175x35	656525	300	81.84	4	16	656425	300	71.28	4	16	656825	300	81.84	4	16
200x45	656526	300	96.16	2	10	656426	300	85.60	2	10	656826	300	96.16	2	10

65GH															
															
	COD.	4 km/h	Euro	■	■	COD.	4 km/h	Euro	■	■	COD.	4 km/h	Euro	■	■
150x35	657214	490	66.53	4	36	658214	490	56.44	4	36	657334	490	78.92	4	36
200x45	657206	500	90.52	2	10	658206	500	79.50	2	10	657326	500	102.91	2	10

I RUOTE IN POLIURETANO TR,
NUCLEO IN GHISA MECCANICA

D TR POLYURETHAN-RÄDER,
GUßEISENKERN

GB TR POLYURETHANE WHEELS,
CAST IRON CENTRE

E RUEDAS DE POLIURETANO TR,
NUCLEO DE HIERRO FUNDIDO MECANICO

F ROUES EN POLYURETHANE TR,
CORPS EN FONTE MECANIQUE

RU КОЛЕСА ИЗ ПОЛИУРЕТАНА TR,
ОСНОВАНИЕ ИЗ МЕХАНИЧЕСКОГО ЧУГУНА

65GH

65GH



COD.	4 km/h	Euro	P		COD.	4 km/h	Euro	P		COD.	4 km/h	Euro	P	
			■	■				■	■					

150x30	657404	400	74.98	4	36	658404	400	56.40	4	36	656624	400	91.59	4	36
150x35	657414	490	78.56	4	36	658414	490	59.98	4	36	656634	490	95.17	4	36
175x35	657405	650	90.84	4	16	658405	650	70.42	4	16	656625	650	107.45	4	16
200x45	657406	750	105.17	2	10	658406	750	84.75	2	10	656626	750	121.78	2	10
250x50	657408	750	140.67	1	4	658408	750	118.00	1	4	656628	750	157.28	1	4

65GH



COD.	4 km/h	Euro	PT		COD.	4 km/h	Euro	PT		COD.	4 km/h	Euro	PT	
			■	■				■	■					

150x35	657444	490	82.18	4	36	658414	490	59.98	4	36	658314	490	98.79	4	36
175x35	657435	650	94.77	4	16	658405	650	70.42	4	16	658305	650	111.39	4	16
200x45	657436	900	109.10	2	10	658406	900	84.75	2	10	658306	900	125.71	2	10

65GH



COD.	4 km/h	Euro	EP		COD.	4 km/h	Euro	EP		COD.	4 km/h	Euro	EP	
			■	■				■	■					

150x30	657804	400	130.90	4	36	658804	400	74.06	4	36					
150x35	657814	490	134.48	4	36	658814	490	77.65	4	36	656914	490	151.09	4	36
175x35	657805	650	145.28	2	16	658805	650	88.93	2	16	656915	650	161.89	2	16
200x45	657806	1000	159.61	2	10	658806	1000	103.25	2	10	656916	1000	176.22	2	10
250x50	657808	1200	246.67	1	4	658808	1200	169.18	1	4					



GALVANISED

COD. Euro

150x30	100033		5.87											
150x35	100033		5.87											
175x35	100034		7.75											
200x45	100035		10.69											

I RUOTE IN POLIURETANO TR AD ALTO SPESSORE, NUCLEO IN ALLUMINIO

D TR POLYURETHANE-RÄDER HOHE DICKE, ALUKERN

GB TR HIGH THICKNESS POLYURETHANE WHEELS, ALUMINIUM CENTRE

E RUEDAS DE POLIURETANO TR ALTO ESPESOR, NUCLEO DE ALUMINIO



F ROUES EN POLYURETHANE TR HAUT EPAISSEUR, CORPS EN ALUMINIUM

RU КОЛЕСА ИЗ ПОЛИУРЕТАНА TR ВЫСОКОЙ ПЛОТНОСТИ, ОСНОВАНИЕ ИЗ АЛЮМИНИЯ

65HT





65HT



															
	COD.	4 km/h	Euro	■	■	COD.	4 km/h	Euro	■	■					
100x40	652302	350	25.85	12	150	654302	350	19.79	12	150					
125x40	652303	450	38.19	6	90	654303	450	30.02	6	90					
160x50	652304	700	43.85	6	60	654304	700	35.68	6	60					
180x50	652305	750	53.56	4	26	654305	750	45.38	4	26					
200x50	652306	800	59.06	4	26	654306	800	50.88	4	26					
250x50	652308	1000	73.83	1	12	654308	1000	64.82	1	12					





65HT



																				
	COD.	4 km/h	Euro	■	■	COD.	4 km/h	Euro	■	■	COD.	4 km/h	Euro	■	■					
100x40	655302	350	44.90	6	50	655412	350	35.21	6	50	655502	350	51.52	6	50					

65HT



																				
	COD.	4 km/h	Euro	■	■	COD.	4 km/h	Euro	■	■	COD.	4 km/h	Euro	■	■					
125x40	655303	450	65.87	4	36	655403	450	47.73	4	36	655503	450	82.48	4	36					
160x50	655310	700	76.42	4	16	655414	700	57.85	4	16	655504	700	93.04	4	16					
180x50	655305	750	90.20	4	16	655415	750	69.78	4	16	655505	750	106.81	4	16					
200x50	655316	750	95.70	2	10	655416	750	75.28	2	10	655506	750	112.31	2	10					
250x50	655318	750	115.74	1	4	655418	750	93.08	1	4	655508	750	132.36	1	4					

I RUOTE IN POLIURETANO TR AD ALTO SPESSORE,
NUCLEO IN ALLUMINIO

D TR POLYURETHANE-RÄDER HOHE DICKE,
ALUKERN















GB TR HIGH THICKNESS POLYURETHANE WHEELS,
ALUMINIUM CENTRE















E RUEDAS DE POLIURETANO TR ALTO ESPESOR,
NUCLEO DE ALUMINIO















F ROUES EN POLYURETHANE TR HAUT EPAISSEUR,
CORPS EN ALUMINIUM

RU КОЛЕСА ИЗ ПОЛИУРЕТАНА TR ВЫСОКОЙ
ПЛОТНОСТИ, ОСНОВАНИЕ ИЗ АЛЮМИНИЯ

65HT

65HT															
			PT				PT				PT				
	COD.	 4 km/h	Euro			COD.	 4 km/h	Euro			COD.	 4 km/h	Euro		
125x40	655333	450	69.49	4	36	655403	450	47.73	4	36	655533	450	86.10	4	36
160x50	655344	700	80.05	4	16	655414	700	57.85	4	16	655544	700	96.66	4	16
180x50	655335	750	94.13	4	16	655415	750	69.78	4	16	655535	750	110.75	4	16
200x50	655336	800	99.63	2	10	655416	800	75.28	2	10	655536	800	116.24	2	10

65HT															
			EE MHD				EE MHD				EE MHD				
	COD.	 4 km/h	Euro			COD.	 4 km/h	Euro			COD.	 4 km/h	Euro		
100x40	655602	350	108.31	2	50	655702	350	65.57	2	50	655802	350	139.23	2	50
125x40	655603	450	120.65	2	36	655703	450	77.90	2	36	655803	450	151.57	2	36
160x50	655614	700	126.31	2	16	655714	700	83.57	2	16	655814	700	157.23	2	16
180x50	655605	750	136.02	1	16	655705	750	93.27	1	16	655805	750	166.94	1	16
200x50	655606	800	141.52	1	10	655706	800	98.77	1	10	655806	800	172.43	1	10

65HT															
			EES MHD				EES MHD				EES MHD				
	COD.	 4 km/h	Euro			COD.	 4 km/h	Euro			COD.	 4 km/h	Euro		
160x50	655004	700	248.27	2	16	657104	700	205.31	2	16	654904	700	289.67	2	16
200x50	655006	800	263.47	1	10	657106	800	220.52	1	10	654906	800	304.87	1	10
250x50	655008	1000	334.65	1	8	657108	1000	259.09	1	8	654908	1000	376.05	1	8

Accessori (contropiastre, codoli, bloccaggi direzionali, parapiedi) : pag 142-144

Accessories (counter-plates, stems, directional locks, footguards): page 142-144

Accessoires (contre-platines, tiges, blocages directionnels, pare-pieds): page 142-144

Zubehöre (Gegenplatten, Zapfen, Richtungsfeststeller, Fußschutz): Seite 142-144

Accesorios (contraplacas, espigas, posicionadores direccionales, guardapié): pág 142-144

ДОПОЛНИТЕЛЬНЫЕ ПРИНАДЛЕЖНОСТИ (Панели, стержни, Фиксатор направления движения, Защиты для ног): стр. 142-144

I RUOTE IN POLIURETANO TR CON PROFILO BOMBATO ERGONOMICO, NUCLEO IN ALLUMINIO

D TR POLYURETHAN-RÄDER MIT LEICHT BALLIGEM PROFIL, KERN AUS ALUMINIUM















GB TR POLYURETHANE WHEELS WITH ERGONOMIC ROUND PROFILE, ALUMINIUM CENTRE























E RUEDAS DE POLIURETANO TR CON PERFIL REDONDO ERGONOMICO, NUCLEO DE ALUMINIO























F ROUES EN POLYURETHANE TR AVEC PROFIL ERGONOMIQUE ROND, CORPS EN ALUMINIUM























RU КОЛЕСА ИЗ ПОЛИУРЕТАНА TR С ЗАКРУГЛЕННЫМ ПРОФИЛЕМ ОСНОВАНИЕ ИЗ АЛЮМИНИЯ

65ER

65ER										
										
	COD.	 4 km/h	Euro			COD.	 4 km/h	Euro		
125x40	652503	450	39.34	6	90	654503	450	31.16	6	90
160x50	652504	700	45.17	6	60	654504	700	36.99	6	60
200x50	652506	800	60.57	4	26	654506	800	52.39	4	26
250x50	652508	1000	76.02	4	24	654508	1000	67.02	4	24

65ER															
			 M		 M		 M		 M		M				
	COD.	 4 km/h	Euro			COD.	 4 km/h	Euro			COD.	 4 km/h	Euro		
160x50	655904	500	65.71	4	16	656004	500	55.62	4	16	656304	500	78.10	4	16
200x50	655906	500	82.56	2	10	656006	500	71.54	2	10	656306	500	94.95	2	10

65ER															
			 P		 P		 P		 P		P				
	COD.	 4 km/h	Euro			COD.	 4 km/h	Euro			COD.	 4 km/h	Euro		
125x40	655913	450	67.02	4	36	656013	450	50.81	4	36	656313	450	83.63	4	36
160x50	655914	700	77.74	4	16	656014	700	59.16	4	16	656314	700	94.35	4	16
200x50	655916	750	97.21	2	10	656016	750	76.79	2	10	656316	750	113.82	2	10

65ER															
			 PT		 PT		 PT		 PT		PT				
	COD.	 4 km/h	Euro			COD.	 4 km/h	Euro			COD.	 4 km/h	Euro		
125x40	655953	450	70.64	4	36	656013	450	50.81	4	36	656353	450	87.25	4	36
160x50	655954	700	81.36	4	16	656014	700	59.16	4	16	656354	700	97.97	4	16
200x50	655956	800	101.14	2	10	656016	800	76.79	2	10	656356	800	117.75	2	10

I RUOTE IN POLIURETANO TR CON PROFILO BOMBATO ERGONOMICO, NUCLEO IN ALLUMINIO

D TR POLYURETHAN-RÄDER MIT LEICHT BALLIGEM PROFIL, KERN AUS ALUMINIUM



GB TR POLYURETHANE WHEELS WITH ERGONOMIC ROUND PROFILE, ALUMINIUM CENTRE



E RUEDAS DE POLIURETANO TR CON PERFIL REDONDO ERGONOMICO, NUCLEO DE ALUMINIO

F ROUES EN POLYURETHANE TR AVEC PROFIL ERGONOMIQUE ROND, CORPS EN ALUMINIUM

RU КОЛЕСА ИЗ ПОЛИУРЕТАНА TR С ЗАКРУГЛЕННЫМ ПРОФИЛЕМ ОСНОВАНИЕ ИЗ АЛЮМИНИЯ

65ER

65ER															
	COD.	4 km/h	Euro	■	■	COD.	4 km/h	Euro	■	■	COD.	4 km/h	Euro	■	■
160x50	655924	700	133.66	4	16	656024	700	76.83	4	16	656324	700	150.27	2	16
200x50	655926	800	151.65	2	10	656026	800	95.29	2	10	656326	800	168.26	1	10

65ER															
	COD.	4 km/h	Euro	■	■	COD.	4 km/h	Euro	■	■	COD.	4 km/h	Euro	■	■
125x40	655933	450	121.80	2	36	656033	450	79.05	2	36	656333	450	152.71	2	36
160x50	655934	700	127.63	2	16	656034	700	84.88	2	16	656334	700	158.54	2	16
200x50	655936	800	143.03	1	10	656036	800	100.28	1	10	656336	800	173.94	1	10

65ER															
	COD.	4 km/h	Euro	■	■	COD.	4 km/h	Euro	■	■	COD.	4 km/h	Euro	■	■
160x50	657904	700	249.58	2	16	658504	700	206.63	2	16	659904	700	290.98	2	16
200x50	657906	800	264.98	1	10	658506	800	222.03	1	10	659906	800	306.38	1	10

Accessori (contropiastre, codoli, bloccaggi direzionali, parapiedi) : pag 142-144

Accessories (counter-plates, stems, directional locks, footguards): page 142-144

Accessoires (contre-platines, tiges, blocages directionnels, pare-pieds): page 142-144

Zubehöre (Gegenplatten, Zapfen, Richtungsfeststeller, Fußschutz): Seite 142-144

Accesorios (contraplacas, espigas, posicionadores direccionales, guardapié): pág 142-144

ДОПОЛНИТЕЛЬНЫЕ ПРИНАДЛЕЖНОСТИ (Панели, стержни, Фиксатор направления движения, Зашиты для ног): стр. 142-144

RUOTE IN POLIURETANO ESD TR,
NUCLEO IN ALLUMINIO

D ESD TR POLYURETHAN-RÄDER,
ALUKERN



























ESD TR POLYURETHANE WHEELS,
ALUMINIUM CENTRE





























E RUEDAS DE POLIURETANO ESD TR,
NUCLEO DE ALUMINIO





























ROUES EN POLYURETHANE ESD TR,
CORPS EN ALUMINIUM

RU КОЛЕСА ИЗ ПОЛИУРЕТАНА ESD TR,
ОСНОВАНИЕ ИЗ АЛЮМИНИЯ

65ESD

65ESD																						
																						
	COD.		Euro			COD.		Euro			COD.		Euro			COD.		Euro				
		4 km/h					4 km/h					4 km/h					4 km/h					
80x25	652101ESD	170	26.39	12	150	654101ESD	170	20.69	12	150	659301ESD	170	32.81	12	62	658201ESD	170	30.18	6	62		
100x30	652102ESD	200	31.08	12	150	654102ESD	200	25.02	12	150	659302ESD	200	37.50	12	50	658202ESD	200	34.87	6	50		
125x35	652103ESD	320	35.41	6	90	654103ESD	320	29.34	6	90	659303ESD	220	44.62	12	36	658203ESD	220	40.38	6	36		
150x40	651104ESD	480	46.99	4	60	653104ESD	480	38.81	4	60	659304ESD	300	63.07	4	36	658104ESD	300	57.44	4	36		
160x50	652114ESD	640	58.37	2	60	654114ESD	640	50.20	2	60	659514ESD	300	74.46	4	16	658114ESD	300	68.83	4	16		
200x50	651106ESD	680	70.93	4	26	653106ESD	680	61.92	4	26	659306ESD	300	88.01	2	10	658106ESD	300	81.90	2	10		

65ESD																					
																					
	COD.		Euro			COD.		Euro			COD.		Euro			COD.		Euro			
		4 km/h					4 km/h					4 km/h					4 km/h				
80x25	656501ESD	170	39.43	12	62																
100x30	656502ESD	200	44.12	12	50																
125x35	656503ESD	220	51.24	12	36																
150x40	656504ESD	300	74.00	4	36	659604ESD	480	59.36	4	36	658104ESD	480	57.44	4	36	659704ESD	480	79.92	4	36	
160x50	656514ESD	300	86.01	4	16	659614ESD	500	70.74	4	16	658114ESD	500	68.83	4	16	659714ESD	500	91.31	4	16	
200x50	656506ESD	300	98.56	2	10	659606ESD	500	83.92	2	10	658106ESD	500	81.90	2	10	659706ESD	500	105.31	2	10	

65ESD																					
																					
	COD.		Euro			COD.		Euro			COD.		Euro			COD.		Euro			
		4 km/h					4 km/h					4 km/h					4 km/h				
100x30	657602ESD	200	50.13	12	50	658602ESD	200	40.44	6	50	656602ESD	200	56.75	12	50						
125x35	657603ESD	320	55.07	12	36	658603ESD	320	44.95	6	36	656603ESD	320	61.50	4	36						
150x40	657604ESD	480	79.56	4	36	658604ESD	480	60.98	4	36						656604ESD	480	96.17	4	36	
160x50	657514ESD	640	90.95	4	16	658614ESD	640	72.37	4	16						656614ESD	640	107.56	4	16	
200x50	657606ESD	680	107.57	2	10	658606ESD	680	87.15	2	10						656606ESD	680	129.46	2	10	

65_{ESD}

I RUOTE IN POLIURETANO ESD TR,
NUCLEO IN ALLUMINIO

D ESD TR POLYURETHAN-RÄDER,
ALUKERN

GB ESD TR POLYURETHANE WHEELS,
ALUMINIUM CENTRE

E RUEDAS DE POLIURETANO ESD TR,
NUCLEO DE ALUMINIO

F ROUES EN POLYURETHANE ESD TR,
CORPS EN ALUMINIUM

RU КОЛЕСА ИЗ ПОЛИУРЕТАНА ESD TR,
ОСНОВАНИЕ ИЗ АЛЮМИНИЯ

65_{ESD}



R \leq $10^\circ\Omega$



R \leq $10^\circ\Omega$



R \leq $10^\circ\Omega$



PT



PT



PT

COD.  4 km/h Euro  

COD.  4 km/h Euro  

COD.  4 km/h Euro  

150x40

657544ESD

480

83.18

4

36

658604ESD

480

60.98

4

36

656674ESD

480

99.79

4

36

160x50

657554ESD

640

94.57

4

16

658614ESD

640

72.37

4

16

656684ESD

640

111.18

4

10

200x50

657546ESD

680

111.50

2

10

658606ESD

680

87.15

2

10

656676ESD

680

128.11

2

10

I RUOTE IN POLIURETANO TR,
NUCLEO IN POLIAMMIDE 6

D TR POLYURETHAN-RÄDER,
KERN AUS POLYAMID 6





















GB TR POLYURETHANE WHEELS,
POLYAMIDE 6 CENTRE













E RUEDAS DE POLIURETANO TR,
NUCLEO DE POLIAMIDA 6



















F ROUES EN POLYURETHANE TR,
CORPS EN POLYAMIDE 6

RU КОЛЕСА ИЗ ПОЛИУРЕТАНА TR,
ОСНОВАНИЕ ИЗ ПОЛИАМИДА 6

66

66																								
		 				COD.		Euro			COD.		Euro			COD.		Euro			COD.		Euro	
80x25	661101	150	8.26	12	150	664201	150	14.68	12	62	665701	150	12.05	6	62	666601	150	21.30	12	62				
100x30	661102	200	10.43	12	150	664202	200	16.85	12	50	665702	200	14.22	6	50	666602	200	23.47	12	50				
125x30	661103	250	15.73	6	90	664203	220	24.94	12	36	665703	220	20.70	6	36	666603	220	31.57	12	36				
125x30 PG						664213	220	29.52	6	36	665713	220	24.70	6	36	666643	220	36.14	6	36				
150x40	661104	400	19.67	6	60	664204	300	35.75	4	36	665704	300	30.12	4	36	666604	300	46.31	4	36				
175x40	661105	470	31.21	4	26	664205	300	48.28	4	16	665705	300	42.18	4	16	666605	300	58.84	4	16				
200x50 F. 20	661106	600	39.34	4	26	664206	300	56.42	2	10	665706	300	50.31	2	10	666606	300	66.97	2	10				
200x50 F. 25	661206	600	39.34	4	26																			
250x60	661108	1000	66.10	2	12																			

66																							
		 				COD.		Euro			COD.		Euro										
80x25	667701	150	14.68	12	62	666401	150	21.30	12	62													
100x30	667702	200	16.85	12	50	666402	200	23.47	12	50													
125x30	667703	220	24.94	6	36	666403	220	31.57	6	36													
150x40	667704	300	35.75	4	36	666404	300	46.31	4	36													
175x40	667705	300	48.28	4	16	666405	300	58.84	4	16													
200x50	667706	300	56.42	2	10	666406	300	66.97	2	10													

66																							
		 				COD.		Euro			COD.		Euro			COD.		Euro					
150x40	664304	400	40.21	4	36	665704	400	30.12	4	36	668704	400	52.60	4	36								
200x50	664306	500	61.33	2	10	665706	500	50.31	2	10	668706	500	73.72	2	10								

I RUOTE IN POLIURETANO TR,
NUCLEO IN POLIAMMIDE 6

D TR POLYURETHAN-RÄDER,
KERN AUS POLYAMID 6

GB TR POLYURETHANE WHEELS,
POLYAMIDE 6 CENTRE

E RUEDAS DE POLIURETANO TR,
NUCLEO DE POLIAMIDA 6

F ROUES EN POLYURETHANE TR,
CORPS EN POLYAMIDE 6

RU КОЛЕСА ИЗ ПОЛИУРЕТАНА TR,
ОСНОВАНИЕ ИЗ ПОЛИАМИДА 6

66

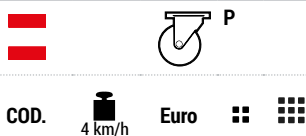

	COD.	4 km/h	Euro	12	50	COD.	4 km/h	Euro	6	50	COD.	4 km/h	Euro	12	50
100x30	667102	200	29.48	12	50	668102	200	19.79	6	50	669002	200	36.10	12	50
125x30	667103	250	35.40	12	36	668103	250	25.27	6	36	669003	250	42.02	12	36

66

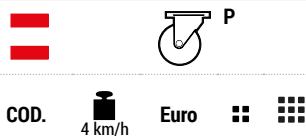

	COD.	4 km/h	Euro	4	36	COD.	4 km/h	Euro	4	36	COD.	4 km/h	Euro	4	36
150x40	667604	400	52.24	4	36	668604	400	33.66	4	36	669004	400	68.85	4	36
175x40	667605	470	67.84	4	16	668605	470	47.42	4	16	669005	470	84.46	4	16
200x50	667606	600	75.98	2	10	668606	600	55.56	2	10	669006	600	92.59	2	10

66

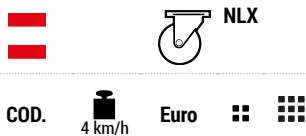

	COD.	4 km/h	Euro	12	62	COD.	4 km/h	Euro	6	62	COD.	4 km/h	Euro	12	62
80x25	664401	150	31.65	12	62	665401	150	20.92	6	62	666701	150	44.04	12	62
100x30	664402	200	33.82	12	50	665402	200	23.09	6	50	666702	200	46.21	12	50
125x30	664403	220	43.42	12	36	665403	220	31.27	6	36	666703	220	55.81	12	36
150x40	664404	300	70.38	4	36	665404	300	50.27	4	36	666704	300	88.84	4	36
175x40	664405	300	87.28	4	16	665405	300	64.90	4	16	666705	300	105.75	4	16
200x50	664406	300	95.42	2	10	665406	300	73.04	2	10	666706	300	113.88	2	10

I RUOTE IN POLIURETANO TR,
NUCLEO IN POLIAMMIDE 6

D TR POLYURETHAN-RÄDER,
KERN AUS POLYAMID 6

GB TR POLYURETHANE WHEELS,
POLYAMIDE 6 CENTRE

E RUEDAS DE POLIURETANO TR,
NUCLEO DE POLIAMIDA 6

F ROUES EN POLYURETHANE TR,
CORPS EN POLYAMIDE 6

RU КОЛЕСА ИЗ ПОЛИУРЕТАНА TR,
ОСНОВАНИЕ ИЗ ПОЛИАМИДА 6

66

66	INOX					INOX									
	COD.	4 km/h	Euro	■	■	COD.	4 km/h	Euro	■	■					
80x25	667901	150	31.65	12	62	668801	150	44.04	12	62					
100x30	667902	200	33.82	12	50	668802	200	46.21	12	50					
125x30	667903	220	43.42	6	36	668803	220	55.81	6	36					
150x40	667904	300	70.38	4	36	668804	300	88.84	4	36					
175x40	667905	300	87.28	4	16	668805	300	105.75	4	16					
200x50	667906	300	95.42	2	10	668806	300	113.88	2	10					

66	INOX					INOX					INOX									
	COD.	4 km/h	Euro	■	■	COD.	4 km/h	Euro	■	■	COD.	4 km/h	Euro	■	■					
150x40	667004	400	128.77	4	36	667114	400	69.70	4	36	667214	400	162.91	4	36					
175x40	667005	470	143.84	4	16	667115	470	84.35	4	16	667215	470	177.98	4	16					
200x50	667006	600	151.98	2	10	667116	600	92.49	2	10	667216	600	186.11	2	10					

66																									
	COD.	4 km/h	Euro	■	■	COD.	4 km/h	Euro	■	■	COD.	4 km/h	Euro	■	■	COD.	4 km/h	Euro	■	■					
80x25	663101	150	9.60	12	150	664501	150	16.02	12	62	665901	150	13.39	6	62	666621	150	22.65	12	62					
100x30	663102	200	11.78	12	150	664502	200	18.20	12	50	665902	200	15.57	6	50	666622	200	24.82	12	50					
125x30	663103	250	17.18	6	90	664503	220	26.39	12	36	665903	220	22.15	6	36	666623	220	33.02	12	36					
125x30 PG						664513	220	30.97	6	36	665913	220	26.14	6	36	666653	220	37.59	6	36					
150x40	663104	400	21.11	6	60	664504	300	37.20	4	36	665904	300	31.57	4	36	666624	300	47.75	4	36					
175x40	663105	470	32.65	4	26	664505	300	49.73	4	16	665905	300	43.63	4	16	666625	300	60.29	4	16					
200x50 F. 20	663106	600	41.41	4	26	664506	300	58.49	2	10	665906	300	52.38	2	10	666626	300	69.04	2	10					
200x50 F. 25	663116	600	41.41	4	26																				
250x60	663108	1000	69.20	2	12																				

I RUOTE IN POLIURETANO TR,
NUCLEO IN POLIAMMIDE 6

D TR POLYURETHAN-RÄDER,
KERN AUS POLYAMID 6

























GB TR POLYURETHANE WHEELS,
POLYAMIDE 6 CENTRE

























E RUEDAS DE POLIURETANO TR,
NUCLEO DE POLIAMIDA 6





















F ROUES EN POLYURETHANE TR,
CORPS EN POLYAMIDE 6

RU КОЛЕСА ИЗ ПОЛИУРЕТАНА TR,
ОСНОВАНИЕ ИЗ ПОЛИАМИДА 6

66

66																					
				NL				NL				M				M					
	COD.	 4 km/h	Euro			COD.	 4 km/h	Euro			COD.	 4 km/h	Euro			COD.	 4 km/h	Euro			
80x25	667801	150	16.02	12	62	666421	150	22.65	12	62											
100x30	667802	200	18.20	12	50	666422	200	24.82	12	50											
125x30	667803	220	26.39	6	36	666423	220	33.02	6	36											
150x40	667804	300	37.20	4	36	666424	300	47.75	4	36	664804	400	41.66	4	36	665904	400	31.57	4	36	
175x40	667805	300	49.73	4	16	666425	300	60.29	4	16											
200x50	667806	300	58.49	2	10	666426	300	69.04	2	10	664806	500	63.40	2	10	665906	500	52.38	2	10	

66																					
				M				P				P				P					
	COD.	 4 km/h	Euro			COD.	 4 km/h	Euro			COD.	 4 km/h	Euro			COD.	 4 km/h	Euro			
100x30						667302	200	30.82	12	50	668302	200	21.13	12	50	669102	200	37.45	12	50	
125x30						667303	250	36.85	12	36	668303	250	26.72	12	36	669103	250	43.47	12	36	
150x40	668904	400	54.05	4	36																
200x50	668906	500	75.79	2	10																

66																				
				P				P				P								
	COD.	 4 km/h	Euro			COD.	 4 km/h	Euro			COD.	 4 km/h	Euro							
150x40	667504	400	53.69	4	36	668504	400	35.11	4	36	669104	400	70.30	4	36					
175x40	667505	470	69.29	4	16	668505	470	48.87	4	16	669105	470	85.91	4	16					
200x50	667506	600	78.05	2	10	668506	600	57.63	2	10	669106	600	94.66	2	10					

I RUOTE IN POLIURETANO TR,
NUCLEO IN POLIAMMIDE 6

D TR POLYURETHAN-RÄDER,
KERN AUS POLYAMID 6





















GB TR POLYURETHANE WHEELS,
POLYAMIDE 6 CENTRE





















E RUEDAS DE POLIURETANO TR,
NUCLEO DE POLIAMIDA 6





F ROUES EN POLYURETHANE TR,
CORPS EN POLYAMIDE 6

RU КОЛЕСА ИЗ ПОЛИУРЕТАНА TR,
ОСНОВАНИЕ ИЗ ПОЛИАМИДА 6

66

66								INOX						INOX						INOX				
								NLX						NLX						NLX				
	COD.		4 km/h	Euro			COD.		4 km/h	Euro			COD.		4 km/h	Euro			COD.		4 km/h	Euro		
80x25	663201	150	11.05	12	150	664601	150	34.44	12	62		665601	150	23.71	6	62		666721	150	46.83	12	62		
100x30	663202	200	13.23	12	150	664602	200	36.62	12	50		665602	200	25.89	6	50		666722	200	49.01	12	50		
125x30	663203	250	19.67	6	90	664603	220	47.35	12	36		665603	220	35.20	6	36		666723	220	59.74	12	36		
150x40	663204	400	23.60	6	60	664604	300	74.31	4	36		665604	300	54.20	4	36		666724	300	92.78	4	36		
175x40	663205	470	35.14	4	26	664605	300	91.21	4	16		665605	300	68.84	4	16		666725	300	109.68	4	16		
200x50	663206	600	45.55	4	26	664606	300	101.63	2	10		665606	300	79.25	2	10		666726	300	120.09	2	10		
250x60	663208	1000	73.34	2	12																			

66								INOX						INOX						INOX				
								NLX						PX						PX				
	COD.		4 km/h	Euro			COD.		4 km/h	Euro			COD.		4 km/h	Euro			COD.		4 km/h	Euro		
80x25	668001	150	34.44	12	62	668821	150	46.83	12	62														
100x30	668002	200	36.62	12	50	668822	200	49.01	12	50														
125x30	668003	220	47.35	6	36	668823	220	59.74	6	36														
150x40	668004	300	74.31	4	36	668824	300	92.78	4	36		667314	400	132.71	4	36		667414	400	73.63	4	36		
175x40	668005	300	91.21	4	16	668825	300	109.68	4	16		667315	470	147.78	4	16		667415	470	88.29	4	16		
200x50	668006	300	101.63	2	10	668826	300	120.09	2	10		667316	600	158.19	2	10		667416	600	98.70	2	10		

66																					
																					
	COD.		4 km/h	Euro																	
150x40	667514	400	166.84	4	36																
175x40	667515	470	181.91	4	16																
200x50	667516	600	192.32	2	10																

I RUOTE IN POLIURETANO TR,
NUCLEO IN POLIAMMIDE 6

D TR POLYURETHAN-RÄDER,
KERN AUS POLYAMID 6





















GB TR POLYURETHANE WHEELS,
POLYAMIDE 6 CENTRE



E RUEDAS DE POLIURETANO TR,
NUCLEO DE POLIAMIDA 6







F ROUES EN POLYURETHANE TR,
CORPS EN POLYAMIDE 6

RU КОЛЕСА ИЗ ПОЛИУРЕТАНА TR,
ОСНОВАНИЕ ИЗ ПОЛИАМИДА 6

66

66																											
						COD.		Euro			COD.		Euro			COD.		Euro			COD.		Euro				
80x25	662101	150	15.99	12	150	664101	150	10.29	12	150																	
100x30	662102	200	23.68	12	150	664102	200	17.62	12	150																	
125x30	662103	250	25.45	6	90	664103	250	18.73	6	90																	
175x40	662105	470	49.77	4	26	664105	470	41.60	4	26																	
200x50 F. 20	662106	600	52.64	4	26	664106	600	43.64	4	26	665306	500	74.63	2	10	665806	500	63.61	2	10							
200x60 F. 25	662126	600	52.86	4	26	664106	600	43.64	4	26																	

66										
						COD.		Euro		
200x50 F. 20	669206	500	87.02	2	10					

	 GALVANISED					 INOX				
	COD.	Euro				COD.	Euro			
80x25	100461	2.02								
100x30	100031	3.00				100231	3.00			
125x30	100032	3.17				100232	3.17			
150x40	100033	5.87				100234	7.15			
175x40	100034	7.75								
200x50	100035	10.69								

Per ordinare ruote e supporti montati con parafili, indicare il suffisso PF dopo il codice del complessivo ruota e supporto
 To order castors fitted with threadguards, please add "PF" to the complete unit code
 Pour commander les roues et roulettes avec pare-fils montés on doit indiquer après le code de la référence le suffixe "PF"
 Falls ein Fadenschutz gewünscht wird, bitte der Artikel-Nr. die Abkürzung "PF" hinzufügen
 Para solicitar un artículo con placa anti-hilos se necesita la sigla PF despues del código del artículo de la rueda con soporte
 Чтобы заказать колеса и опоры с нитезащитным устройством, необходимо указать аббревиатуру PF после кода узла колесо + опора.

Accessori (contropiastre, codoli, bloccaggi direzionali, parapiedi) : pag 142-144
 Accessories (counter-plates, stems, directional locks, footguards): page 142-144
 Accessoires (contre-platines, tiges, blocages directionnels, pare-pieds): page 142-144
 Zubehör (Gegenplatten, Zapfen, Richtungsfeststeller, Fußschutz): Seite 142-144
 Accesorios (contraplacas, espigas, posicionadores direccionales, guardapié): pág 142-144
 ДОПОЛНИТЕЛЬНЫЕ ПРИНАДЛЕЖНОСТИ (Панели, стержни, Фиксатор направления движения, Защиты для ног): стр. 142-144

I RUOTE MONOLITICHE IN RESINA FENOLICA TERMOINDURENTE

D EINTEILIGE HARZRÄDER WÄRMEHÄTEND







GB THERMOSETTING PHENOLIC RESIN SOLID WHEELS





























E RUEDAS MONOLITICAS DE RESINA FENOLICA TERMOENDURENTE





























F ROUES MONOLITHIQUES EN RESINE PHENOLIQUE THERMODURCISSABLE

RU ЛИТЫЕ КОЛЁСА ИЗ ТЕРМОРЕАКТИВНОЙ СМОЛЫ

67

67															
		 	COD.	 4 km/h	Euro	 									
80x35	672201	150	6.43	12	300										
100x35 F. 12	671102	200	9.92	12	300										
100x35 F. 15	672202	200	9.92	12	300										
125x35	672203	300	15.40	6	180										
150x50	672104	300	47.06	4	120										
200x50	672106	500	64.62	4	50										

67																												
		 	 NL	COD.	 4 km/h	Euro	 	 	 NL	COD.	 4 km/h	Euro	 	 	 NL	COD.	 4 km/h	Euro	 	AXLE SET								
80x35	677101	150	12.84	12	124	678101	150	10.22	6	124	676101	150	12.84	12	124													
80x35	677201	150	13.73	12	124	677401	150	11.11	6	124	677501	150	13.73	12	124													
100x35	677102	200	16.33	12	100	678102	200	13.70	6	100	676102	200	16.33	12	100													
100x35	677202	200	17.22	12	100	677402	200	14.59	6	100	677502	200	17.22	12	100													
125x35	677103	220	24.61	12	70	678103	220	20.37	6	70	676103	220	24.61	12	70													
150x50	677314	300	63.15	4	70	678304	300	57.51	4	70																		
200x50	677316	300	81.69	2	20	678306	300	75.59	2	20																		

67																												
		 	 NLX	COD.	 4 km/h	Euro	 	 	 NLX	COD.	 4 km/h	Euro	 	 	 NLX	COD.	 4 km/h	Euro	 	AXLE SET								
80x35	677701	150	29.82	12	62	678701	150	19.09	6	62	676701	150	29.82	12	62													
80x35	677901	150	29.82	12	50	678001	150	19.09	6	62	678201	150	29.82	12	62													
100x35	677702	200	33.31	12	50	678702	200	22.57	6	50	676702	200	33.31	12	50													
100x35	677902	200	33.31	12	50	678002	200	22.57	6	50	678202	200	33.31	12	50													
125x35	677713	220	43.09	12	36	678713	220	30.94	6	36	676703	220	43.09	12	36													
150x50	677704	300	97.78	4	36	678704	300	77.67	4	36																		
200x50	677706	300	120.69	2	10	678706	300	98.31	2	10																		

I RUOTE MONOLITICHE IN RESINA FENOLICA TERMOINDURENTE

D EINTEILIGE HARZRÄDER WÄRMEHÄTEND













GB THERMOSETTING PHENOLIC RESIN SOLID WHEELS

















E RUEDAS MONOLITICAS DE RESINA FENOLICA TERMOENDURENTE







F ROUES MONOLITHIQUES EN RESINE PHENOLIQUE THERMODURCISABLE





















RU ЛИТЫЕ КОЛЁСА ИЗ ТЕРМОРЕАКТИВНОЙ СМОЛЫ

67

67		INOX		INOX										
		 PX		 PX										
	COD.	 4 km/h	Euro			COD.	 4 km/h	Euro						
150x50	677004	300	156.17	4	36	677104	300	97.09	4	36				
200x50	677006	500	177.25	2	10	677106	500	117.76	2	10				

67															
				 NL	 NL										
	COD.	 4 km/h	Euro			COD.	 4 km/h	Euro			COD.	 4 km/h	Euro		
80x35	672501	160	12.02	12	300	674101	160	7.53	12	124	677111	160	23.61	12	124
100x38	672502	240	15.50	12	300	674102	200	11.00	12	124	677112	200	27.10	12	124

67														
		 NL												
	COD.	 4 km/h	Euro											
80x35	676111	160	23.61	12	124									
100x38	676112	200	27.10	12	124									

67				INOX		INOX		INOX							
				 NLX		 NLX		 NLX							
	COD.	 4 km/h	Euro			COD.	 4 km/h	Euro			COD.	 4 km/h	Euro		
80x35	672601	160	17.29	12	300	678801	160	46.90	12	62	678901	160	36.16	6	62
100x38	672602	240	20.78	12	300	678802	200	50.38	12	62	678902	200	39.65	6	62

Accessori (contropiastre, codoli, bloccaggi direzionali, parapiedi) : pag 142-144





Accessories (counter-plates, stems, directional locks, footguards): page 142-144





Accessoires (contre-platines, tiges, blocages directionnels, pare-pieds): page 142-144

Zubehöre (Gegenplatten, Zapfen, Richtungsfeststeller, Fußschutz): Seite 142-144

Accesorios (contraplacas, espigas, posicionadores direccionales, guardapié): pág 142-144

ДОПОЛНИТЕЛЬНЫЕ ПРИНАДЛЕЖНОСТИ (Панели, стержни, Фиксатор направления движения, Зашиты для ног): стр. 142-144

68																				
	COD.	4 km/h	Euro	■	■	COD.	4 km/h	Euro	■	■	COD.	4 km/h	Euro	■	■	COD.	4 km/h	Euro	■	■
65x30	681100	120	2.18	12	300	684500	120	8.60	12	150	685100	120	5.97	6	150					
80x30 Im 39	681111	180	2.73	12	300	684501	180	9.15	12	124	685101	180	6.52	6	124	686801	180	15.77	12	124
100x30 Im 44	681112	300	3.63	12	300	684502	200	10.05	12	100	685102	200	7.42	6	100	686802	200	16.67	12	100
125x38	681103	400	6.25	6	180	684503	220	15.46	12	70	685103	220	11.22	6	70	686803	220	22.09	12	70
125x38 PG						684513	220	20.04	6	70	685143	220	15.21	6	70	686843	220	26.66	6	70
150x45 B	681104	500	9.27	6	120	684512	220	23.06	6	70	685142	220	18.24	6	70					
150x45						684504	300	25.36	4	70	685104	300	19.73	4	70	686804	300	35.91	4	70
175x45	681105	630	14.62	4	50	684505	300	31.70	4	30	685105	300	25.60	4	30	686805	300	42.26	4	30
200x50	681106	730	18.25	4	50	684506	300	35.32	2	20	685106	300	29.22	2	20	686806	300	45.88	2	20
250x60	681108	1200	37.37	2	24	684108	350	86.78	1	8	685108	350	63.46	1	8					

68																				
	COD.	4 km/h	Euro	■	■	COD.	4 km/h	Euro	■	■	COD.	4 km/h	Euro	■	■	COD.	4 km/h	Euro	■	■
65x30	687700	120	8.60	12	150															
80x30	687701	180	9.15	12	124	686701	180	15.77	12	124										
100x30	687702	200	10.05	12	100	686702	200	16.67	12	100	686102	200	12.98	12	100	687102	200	19.60	12	100
125x38	687703	220	15.46	6	70	686703	220	22.09	6	70	686103	220	18.39	6	70	687103	220	25.02	6	70
150x45	687704	300	25.36	4	70	686704	300	35.91	4	70	686104	300	32.69	4	70	687104	300	43.24	4	70
175x45	687705	300	31.70	4	30	686705	300	42.26	4	30										
200x50	687706	300	35.32	2	20	686706	300	45.88	2	20	686106	300	42.65	2	20	687106	300	53.21	2	20

68

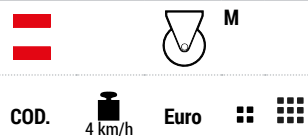
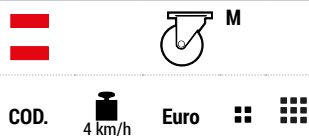

	COD.	4 km/h	Euro	⚡	⚡	COD.	4 km/h	Euro	⚡	⚡	COD.	4 km/h	Euro	⚡	⚡
150x45	684704	500	29.82	4	70	685104	500	19.73	4	70	688204	500	42.21	4	70
200x50	684706	500	40.24	2	20	685106	500	29.22	2	20	688206	500	52.63	2	20

68



	COD.	4 km/h	Euro	⚡	⚡	COD.	4 km/h	Euro	⚡	⚡	COD.	4 km/h	Euro	⚡	⚡
100x30	687502	300	22.68	12	100	688502	300	12.99	6	100	686902	300	29.30	12	100
125x38	687503	350	25.92	12	70	688503	350	15.79	6	70	686903	350	32.54	12	70

68

































	COD.	4 km/h	Euro	⚡	⚡	COD.	4 km/h	Euro	⚡	⚡	COD.	4 km/h	Euro	⚡	⚡
150x45	687504	500	41.85	4	70	688504	500	23.27	4	70	686904	500	58.46	4	70
175x45	687505	630	51.26	4	30	688505	630	30.84	4	30	686905	630	67.88	4	30
200x50	687506	730	54.89	2	20	688506	730	34.47	2	20	686906	730	71.50	2	20

68	INOX					INOX					INOX					INOX				
	COD.	4 km/h	Euro	■	■	COD.	4 km/h	Euro	■	■	COD.	4 km/h	Euro	■	■	COD.	4 km/h	Euro	■	■
80x30	684401	180	26.12	12	62	685401	180	15.39	6	62	689001	180	38.51	12	62	685801	180	26.12	12	62
100x30	684402	200	27.02	12	50	685402	200	16.29	6	50	689002	200	39.41	12	50	685802	200	27.02	12	50
125x38	684403	220	33.94	12	36	685403	220	21.79	6	36	689003	220	46.33	12	36	685803	220	33.94	6	36
150x45B	684408	220	36.96	6	36	685408	220	24.81	6	36										
150x45	684404	300	59.99	4	36	685404	300	39.88	4	36	689004	300	80.19	4	36	685804	300	59.99	4	36
175x45	684405	300	70.70	4	16	685405	300	48.32	4	16	689005	300	89.17	4	16	685805	300	70.70	4	16
200x50	684406	300	74.32	2	10	685406	300	51.95	2	10	689006	300	92.79	2	10	685806	300	74.32	2	10





















68	INOX					INOX					INOX					INOX				
	COD.	4 km/h	Euro	■	■	COD.	4 km/h	Euro	■	■	COD.	4 km/h	Euro	■	■	COD.	4 km/h	Euro	■	■
80x30	686001	180	38.51	12	62															
100x30	686002	200	39.41	12	50															
125x38	686003	220	46.33	6	36															
150x45	686004	300	80.19	4	36	687004	500	118.38	4	36	687114	500	59.31	4	36	687214	500	152.52	2	36
175x45	686005	300	89.17	4	16	687005	630	127.26	4	16	687115	630	67.77	4	16	687215	630	161.40	4	16
200x50	686006	300	92.79	2	10	687006	730	130.89	2	10	687116	730	71.39	2	10	687216	730	165.02	2	10















68	INOX					INOX					INOX									
	COD.	4 km/h	Euro	■	■	COD.	4 km/h	Euro	■	■	COD.	4 km/h	Euro	■	■					
250x60	688307	1200	177.74	1	8	688407	1200	103.32	1	8	688707	1200	208.66	1	8					

















68				
	 	 	 	
	COD.  Euro  	COD.  Euro  	COD.  Euro  	
125x38	689503 250 47.65 70	689604 300 55.85 70	689704 300 78.10 70	
150x45	689504 300 65.16 70	689606 400 76.21 20	689706 400 98.46 20	
200x50	689506 400 85.52 20			





















68				
	 	 		
	COD.  Euro  	COD.  Euro  		
125x38	689513 250 51.27 70	689714 300 81.72 70		
150x45	689514 300 68.79 70	689716 400 102.08 20		
200x50	689516 400 89.14 20			























68				
	 	  NL	  NL	  NL
	COD.  Euro  	COD.  Euro  	COD.  Euro  	COD.  Euro  
80x30 Im 39	683111 180 4.91 12 300	684801 180 11.32 12 124	685301 180 8.69 6 124	686821 180 17.95 12 124
100x30 Im 44	683112 300 5.81 12 300	684802 200 12.22 12 100	685302 200 9.59 6 100	686822 200 18.85 12 100
125x38	683103 400 9.36 6 180	684803 220 18.57 12 70	685303 220 14.32 6 70	686823 220 25.19 12 70
125x38 PG		684813 220 23.14 6 70	685323 220 18.32 6 70	686853 220 29.77 6 70
150x45 B	683104 500 12.38 6 120	684812 220 26.16 6 70	685322 220 21.34 6 70	
150x45		684804 300 28.46 4 70	685304 300 22.83 4 70	686824 300 39.02 4 70
175x45	683105 630 18.25 4 50	684805 300 35.32 4 30	685305 300 29.22 4 30	686825 300 45.88 4 30
200x50 F. 20	683106 730 21.87 4 50	684806 300 38.95 2 20	685306 300 32.84 2 20	686826 300 49.50 2 20
200x50 F. 25	683116 730 21.87 4 50			
250x60	683108 1200 42.96 2 24			









68																
		 NL	 NL	 M	 M											
	COD.	 4 km/h	Euro	 	COD.	 4 km/h	Euro	 	COD.	 4 km/h	Euro	 	COD.	 4 km/h	Euro	 
80x30	687901	180	11.32	12 124	686721	180	17.95	12 124								
100x30	687902	200	12.22	12 100	686722	200	18.85	12 100								
125x38	687903	220	18.57	6 70	686723	220	25.19	6 70								
150x45	687904	300	28.46	4 70	686724	300	39.02	4 70	685004	500	32.92	4 70	685304	500	22.83	4 70
175x45	687905	300	35.32	4 30	686725	300	45.88	4 30								
200x50	687906	300	38.95	2 20	686726	300	49.50	2 20	685006	500	43.86	2 20	685306	500	32.84	2 20

68																
		 M	 P	 P	 P											
	COD.	 4 km/h	Euro	 	COD.	 4 km/h	Euro	 	COD.	 4 km/h	Euro	 	COD.	 4 km/h	Euro	 
100x30					687602	300	24.85	12 100	688602	300	15.16	6 100	686922	300	31.47	12 100
125x38					687603	350	29.02	12 70	688603	350	18.90	6 70	686923	350	35.65	12 70
150x45	689204	500	45.31	4 70												
200x50	689206	500	56.25	2 20												

68																
		 P	 P	 P												
	COD.	 4 km/h	Euro	 	COD.	 4 km/h	Euro	 	COD.	 4 km/h	Euro	 				
150x45	687604	500	44.95	4 70	688604	500	26.37	4 70	686924	500	61.56	4 70				
175x45	687605	630	54.89	4 30	688605	630	34.47	4 30	686925	630	71.50	4 30				
200x50	687606	730	58.51	2 20	688606	730	38.09	2 20	686926	730	75.12	2 20				

68						 INOX					 INOX					 INOX									
						COD.		Euro			COD.		Euro			COD.		Euro			COD.		Euro		
80x30 Im 39	683211	180	5.84	12	300	684601	180	29.23	12	62	685601	180	18.50	6	62	689101	180	41.62	12	62	689101	180	41.62	12	62
100x30 Im 44	683212	300	6.74	12	300	684602	200	30.13	12	50	685602	200	19.40	6	50	689102	200	42.52	12	50	689102	200	42.52	12	50
125x38	683203	400	10.39	6	180	684603	220	38.08	12	36	685603	220	25.93	6	36	689103	220	50.47	12	36	689103	220	50.47	12	36
150x45 B	683204	500	13.41	6	120	684608	220	41.10	6	36	685608	220	28.95	6	36										
150x45						684604	300	64.13	4	36	685604	300	44.02	4	36	689104	300	82.59	4	36	689104	300	82.59	4	36
175x45	683205	630	20.83	4	50	684605	300	76.91	4	16	685605	300	54.53	4	16	689105	300	95.38	4	16	689105	300	95.38	4	16
200x50 F. 20	683206	730	24.46	4	50	684606	300	80.53	2	10	685606	300	58.16	2	10	689106	300	99.00	2	10	689106	300	99.00	2	10
200x50 F. 25	683216	730	24.46	4	50																				

68	 INOX					 INOX					 INOX					 INOX										
							COD.		Euro			COD.		Euro			COD.		Euro			COD.		Euro		
80x30	685901	180	29.23	12	62	686021	180	41.62	12	62																
100x30	685902	200	30.13	12	50	686022	200	42.52	12	50																
125x38	685903	220	38.08	6	36	686023	220	50.47	6	36																
150x45	685904	300	64.13	4	36	686024	300	82.59	4	36	687314	500	122.52	4	36	687414	500	63.45	4	36	687414	500	63.45	4	36	
175x45	685905	300	76.91	4	16	686025	300	95.38	4	16	687315	630	133.47	4	16	687415	630	73.98	4	16	687415	630	73.98	4	16	
200x50	685906	300	80.53	2	10	686026	300	99.00	2	10	687316	730	137.10	2	10	687416	730	77.60	2	10	687416	730	77.60	2	10	

68	 INOX																								
						COD.		Euro																	
150x45	687514	500	156.66	4	36																				
175x45	687515	630	167.61	4	16																				
200x50	687516	730	171.23	2	10																				

68				
				NL
	COD.	4 km/h	Euro	
200x50 F. 20	683306	730	31.56	4 50
200x50 F. 25	683316	730	31.76	4 50

68				
		NL		NL
	COD.	4 km/h	Euro	
200x50	686846	300	59.19	2 20
	688006	300	48.63	2 20
	686606	300	59.19	2 20
	684206	500	53.55	2 20

68				
		M		M
	COD.	4 km/h	Euro	
200x50	685166	500	42.53	2 20
	684306	500	65.94	2 20

68				
		P		P
	COD.	4 km/h	Euro	
200x50	684966	730	68.20	2 20
	685366	730	47.78	2 20
	686946	730	84.81	2 20

I RUOTE MONOLITICHE IN POLIAMMIDE 6

D EINTEILIGE RÄDER AUS POLYAMID 6

GB SOLID POLYAMIDE 6 WHEELS

E RUEDAS MONO-BLOQUE DE POLIAMIDA 6

F ROUES MONOLITHIQUES EN POLYAMIDE 6

RU ЛИТЫЕ КОЛЕСА ИЗ ПОЛИАМИДА 6

68

	● GALVANISED				● INOX											
	COD.		Euro		COD.		Euro									
80x30	100491		2.01													
100x30	100498		2.23													
125x38	100493		2.44													
150x45	100494		2.66		100234		7.15									
175x45	100495		2.66													
200x50	100496		3.19													

Per ordinare ruote e supporti montati con parafili, indicare il suffisso PF dopo il codice del complessivo ruota e supporto

To order castors fitted with threadguards, please add "PF" to the complete unit code

Pour commander les roues at roulettes avec pare-fils montés on doit indiquer après le code de la référence le suffixe "PF"

Falls ein Fadenschutz gewünscht wird, bitte der Artikel-Nr. die Abkürzung "PF" hinzufügen

Para solicitar un artículo con placa anti-hilos se necesita la sigla PF despues del código del artículo de la rueda con soporte

Чтобы заказать колеса и опоры с нитезащитным устройством, необходимо указать аббревиатуру PF после кода узла колесо + опора.

Accessori (contropiastre, codoli, bloccaggi direzionali, parapiedi) : pag 142-144

Accessories (counter-plates, stems, directional locks, footguards): page 142-144

Accessoires (contre-platines, tiges, blocages directionnels, pare-pieds): page 142-144

Zubehöre (Gegenplatten, Zapfen, Richtungsfeststeller, Fußschutz): Seite 142-144

Accesorios (contraplacas, espigas, posicionadores direccionales, guardapié): pag 142-144

ДОПОЛНИТЕЛЬНЫЕ ПРИНАДЛЕЖНОСТИ (Панели, стержни, Фиксатор направления движения, Зашиты для ног): стр. 142-144

I RUOTE MONOLITICHE PER ALTO CARICO
IN POLIAMMIDE 6

D EINTEILIGE RÄDER AUS POLYAMID 6
FÜR HOHE TRAGFÄHIGKEITEN

GB POLYAMIDE 6 SOLID WHEELS
FOR HEAVY LOADS

















E RUEDAS MONO-BLOQUE DE POLIAMIDA 6
PARA GRANDES CARGAS

















F ROUES MONOLITHIQUES EN POLYAMIDE 6
POUR CHARGES ELEVEES

















RU ЛИТЫЕ КОЛЕСА ИЗ ПОЛИАМИДА 6
ДЛЯ ТЯЖЕЛЫХ ГРУЗОВ

68P

68P																				
		 NL	 NL	 NL																
	COD.  4 km/h Euro  	COD.  4 km/h Euro  	COD.  4 km/h Euro  	COD.  4 km/h Euro  																
100x35	681202	400	6.30	12	300															
125x45 PG	681203	650	7.83	6	180	684523	300	21.62	4	70	685113	300	16.80	4	70	686813	300	28.25	4	70
150x45	681204	750	10.76	6	120															
200x50	681206	900	19.87	4	50															

68P																				
		 P	 P	 P																
	COD.  4 km/h Euro  	COD.  4 km/h Euro  	COD.  4 km/h Euro  																	
100x35	687522	350	25.35	12	100	688522	350	15.66	6	100	686912	350	31.97	12	100					

68P																				
		 P	 P	 P																
	COD.  4 km/h Euro  	COD.  4 km/h Euro  	COD.  4 km/h Euro  																	
125x45	687533	650	35.51	4	70	688533	650	19.30	4	70	686913	650	52.12	4	70					
150x45	687524	750	43.34	4	70	688524	750	24.76	4	70	686914	750	59.95	4	70					
200x50	687526	750	56.51	2	20	688526	750	36.87	2	20	686916	750	73.12	2	20					

68P																				
		 PX	 PX	 PX																
	COD.  4 km/h Euro  	COD.  4 km/h Euro  	COD.  4 km/h Euro  																	
125x45	687033	650	115.91	4	36	687133	650	57.87	4	36	687233	650	151.08	4	36					
150x45	687014	750	119.87	4	36	687124	750	60.80	4	36	687224	750	154.01	4	36					
200x50	687016	750	132.51	2	10	687126	750	73.02	2	10	687226	750	166.65	2	10					

I RUOTE MONOLITICHE PER ALTO CARICO
IN POLIAMMIDE 6

D EINTEILIGE RÄDER AUS POLYAMID 6
FÜR HOHE TRAGFÄHIGKEITEN



GB POLYAMIDE 6 SOLID WHEELS
FOR HEAVY LOADS





E RUEDAS MONO-BLOQUE DE POLIAMIDA 6
PARA GRANDES CARGAS





F ROUES MONOLITHIQUES EN POLYAMIDE 6
POUR CHARGES ELEVEES

RU ЛИТЫЕ КОЛЕСА ИЗ ПОЛИАМИДА 6
ДЛЯ ТЯЖЕЛЫХ ГРУЗОВ

68P

68P															
	COD.	4 km/h	Euro	■	■	COD.	4 km/h	Euro	■	■	COD.	4 km/h	Euro	■	■
125x45	688303	650	90.29	2	70	688403	650	47.55	2	70	688703	650	121.21	2	70
150x45	688304	750	93.22	2	70	688404	750	50.48	2	70	688704	750	124.14	2	70
200x50	688306	900	102.33	1	20	688406	900	59.58	1	20	688706	900	133.25	1	20

68P																				
	COD.	4 km/h	Euro	■	■	COD.	4 km/h	Euro	■	■	COD.	4 km/h	Euro	■	■	COD.	4 km/h	Euro	■	■
100x35	683402	350	14.78	12	300	682202	350	8.06	12	300										
125x35	683403	450	17.04	6	180	682203	450	10.32	6	180										
125x45 F. 20	683413	650	19.74	6	180	682213	650	11.56	6	180	684873	300	33.52	4	70	685173	300	28.70	4	70
125x45 F. 25	683423	650	19.94	6	180	682213	650	11.56	6	180										
150x45 F. 20	683404	750	23.10	6	120	682204	750	14.92	6	120										
150x45 F. 25	683424	750	23.31	6	120	682204	750	14.92	6	120										
200x50 F. 20	683406	900	34.82	4	50	682206	900	26.64	4	50										
200x50 F. 25	683426	900	35.80	4	50	682206	900	26.64	4	50										

68P																				
	COD.	4 km/h	Euro	■	■	COD.	4 km/h	Euro	■	■	COD.	4 km/h	Euro	■	■	COD.	4 km/h	Euro	■	■
100x35						684972	350	33.82	12	100	685372	350	24.14	12	100	686952	350	40.45	12	100
125x35						684973	350	36.70	6	70	685373	350	26.58	6	70	686953	350	43.33	6	70
125x45	686863	300	40.15	4	70															

I RUOTE MONOLITICHE PER ALTO CARICO
IN POLIAMMIDE 6

D EINTEILIGE RÄDER AUS POLYAMID 6
FÜR HOHE TRAGFÄHIGKEITEN



















GB POLYAMIDE 6 SOLID WHEELS
FOR HEAVY LOADS



















E RUEDAS MONO-BLOQUE DE POLIAMIDA 6
PARA GRANDES CARGAS













F ROUES MONOLITHIQUES EN POLYAMIDE 6
POUR CHARGES ELEVEES

RU ЛИТЫЕ КОЛЕСА ИЗ ПОЛИАМИДА 6
ДЛЯ ТЯЖЕЛЫХ ГРУЗОВ

68P

68P															
															
	COD.	 4 km/h	Euro			COD.	 4 km/h	Euro			COD.	 4 km/h	Euro		
125x45	684993	650	47.42	4	70	685393	650	31.21	4	70	686933	650	64.03	4	70
150x45	684974	750	55.67	4	70	685374	750	37.09	4	70	686954	750	72.28	4	70
200x50	684976	750	71.46	2	20	685376	750	51.04	2	20	686956	750	88.07	2	20

68P															
															
	COD.	 4 km/h	Euro			COD.	 4 km/h	Euro			COD.	 4 km/h	Euro		
125x45	689303	650	102.20	2	70	689403	650	59.45	2	70	689803	650	133.11	2	70
150x45	689304	750	105.56	2	70	689404	750	62.81	2	70	689804	750	136.48	2	70
200x50	689306	900	117.28	1	20	689406	900	74.53	1	20	689806	900	148.19	1	20

68P												
												
	COD.	 4 km/h	Euro			COD.	 4 km/h	Euro				
125x(45+45)	688072	1300	274.30	2	70	688172	1300	139.22	2	70		
150x(45+45)	688074	1500	281.02	1	70	688174	1500	145.95	1	70		
200x(50+50)	688066	1800	306.01	1	20	688166	1800	170.93	1	20		

Accessori (contropiastre, codoli, bloccaggi direzionali, parapiedi) : pag 142-144

Accessories (counter-plates, stems, directional locks, footguards): page 142-144

Accessoires (contre-platines, tiges, blocages directionnels, pare-pieds): page 142-144

Zubehöre (Gegenplatten, Zapfen, Richtungsfeststeller, Fußschutz): Seite 142-144

Accesorios (contraplacas, espigas, posicionadores direccionales, guardapié): pág 142-144

ДОПОЛНИТЕЛЬНЫЕ ПРИНАДЛЕЖНОСТИ (Панели, стержни, Фиксатор направления движения, Зашиты для ног): стр. 142-144

I RUOTE IN POLIAMMIDE 6
PER CARICHI EXTRA-PESANTI

D EINTEILIGE RÄDER AUS POLYAMID 6
FÜR EXTRA-HOHE TRAGFÄHIGKEITEN















































































GB POLYAMIDE 6 SOLID WHEELS
FOR EXTRA HEAVY LOADS

E RUEDAS MONO-BLOQUE DE POLIAMIDA 6
PARA GRANDES CARGAS

F ROUES MONOLITHIQUES EN POLYAMIDE 6
POUR CHARGES EXTRA-ELEVEES

RU ЛИТЫЕ КОЛЕСА ИЗ ПОЛИАМИДА 6
ДЛЯ ТЯЖЕЛЫХ ГРУЗОВ

68P

68P			EXTRA-HEAVY DUTY WHEELS																	
					PT			PT												
	COD.	 4 km/h	Euro			COD.	 4 km/h	Euro			COD.	 4 km/h	Euro			COD.	 4 km/h	Euro		
200x50 F.20	682126	1500	40.82	4	50	683326	1500	31.82	4	20	682906	900	81.39	2	20	685386	900	57.04	2	20
200x50 F.25	682136	1500	41.03	4	50															
68P																				
				PT			EP			EP			EP							
	COD.	 4 km/h	Euro			COD.	 4 km/h	Euro			COD.	 4 km/h	Euro			COD.	 4 km/h	Euro		
200x50	682916	900	98.00	2	20	682926	1000	131.90	1	20	682936	1000	75.54	1	20	682946	1000	136.84	1	20
68P																				
				EE MHD			EE MHD			EE MHD										
	COD.	 4 km/h	Euro			COD.	 4 km/h	Euro			COD.	 4 km/h	Euro							
200x50	682956	1500	123.28	1	20	682966	1500	80.53	1	20	682986	1500	154.19	1	20					
68P																				
				EEG HD			EEG HD													
	COD.	 4 km/h	Euro			COD.	 4 km/h	Euro												
200x50+50	682996	2000	318.01	1	20	682998	2000	182.94	1	20										

Accessori (contropiastre, codoli, bloccaggi direzionali, parapiedi) : pag 142-144

Accessories (counter-plates, stems, directional locks, footguards): page 142-144

Accessoires (contre-platines, tiges, blocages directionnels, pare-pieds): page 142-144

Zubehöre (Gegenplatten, Zapfen, Richtungsfeststeller, Fußschutz): Seite 142-144

Accesorios (contraplacas, espigas, posicionadores direccionales, guardapié): pág 142-144

ДОПОЛНИТЕЛЬНЫЕ ПРИНАДЛЕЖНОСТИ (Панели, стержни, Фиксатор направления движения, Защиты для ног): стр. 142-144

I RUOTE MONOLITICHE IN POLIAMMIDE 6
CON FIBRA DI VETRO

D EINTEILIGE RÄDER AUS GLASFASERVESTÄRKTEM
POLYAMID 6































GB POLYAMIDE 6 SOLID WHEELS
CHARGED WITH GLASS FIBER































E RUEDAS MONOBLOQUE DE POLIAMIDA 6
REFORZADO CON FIBRA DE VIDRIO

F ROUES MONOLITHIQUES EN POLYAMIDE 6
RENFORCE DE BIBRE DE VERRE

RU ЛИТЫЕ КОЛЕСА ИЗ ПОЛИАМИДА 6
УСИЛЕННОГО СТЕКЛОВОЛОКНОМ

68_{FV}

68 _{FV}																				
																				
	COD.		Euro			COD.		Euro			COD.		Euro			COD.		Euro		
100x30	683502	250	15.57	12	300	684882	220	21.98	12	100	685182	220	19.35	12	100	688082	220	21.98	12	100
125x30	683503	350	17.91	6	180	684883	220	27.12	12	70	685183	220	22.87	12	70	688083	220	27.12	12	70

68 _{FV}																				
																				
	COD.		Euro			COD.		Euro			COD.		Euro			COD.		Euro		
100x30	683602	250	23.95	12	300	684682	220	51.64	12	50	685682	220	39.49	12	50	685982	220	51.64	12	50
125x30	683603	350	26.29	12	180	684683	220	53.98	12	36	685683	220	41.82	12	36	685983	220	53.98	12	36

Accessori (contropiastre, codoli, bloccaggi direzionali, parapiedi) : pag 142-144

Accessories (counter-plates, stems, directional locks, footguards): page 142-144

Accessoires (contre-platines, tiges, blocages directionnels, pare-pieds): page 142-144

Zubehöre (Gegenplatten, Zapfen, Richtungsfeststeller, Fußschutz): Seite 142-144

Accesorios (contraplacas, espigas, posicionadores direccionales, guardapié): pág 142-144

ДОПОЛНИТЕЛЬНЫЕ ПРИНАДЛЕЖНОСТИ (Панели, стержни, Фиксатор направления движения, Зашиты для ног): стр. 142-144

I RUOTE MONOLITICHE
IN GHISA MECCANICA

D EINTEILIGE
GÜßEISENRÄDER





GB CAST IRON
SOLID WHEELS



E RUEDAS MONO-BLOQUE
DE HIERRO FUNDIDO





F ROUES MONOLITHIQUES
EN FONTE MECANIQUE

RU ЛИТЫЕ КОЛЕСА ИЗ
МЕХАНИЧЕСКОГО ЧУГУНА

69

69																					
	COD.	4 km/h	Euro	■	■	COD.	4 km/h	Euro	■	■	COD.	4 km/h	Euro	■	■	COD.	4 km/h	Euro	■	■	
100x30 Im 34	691102	500	11.83	12	300																
100x30 Im 44	691112	500	11.83	12	300	694802	200	18.25	12	100	695702	200	15.62	6	100						
100x40	691202	600	14.03	12	300	694812	200	20.45	12	100	695712	200	17.82	6	100						
125x40 F. 15	691103	700	15.94	6	180	694803	220	25.15	6	70	695703	220	20.91	6	70	697603	350	35.60	6	70	
125x40 F. 20	691203	700	15.94	6	180																
150x45	691104	1200	23.56	4	120	694804	300	39.64	4	70	695704	300	34.01	4	70	697504	750	56.13	4	70	
200x45 F. 20	691106	1400	37.57	4	50											697506	750	74.21	2	20	
200x45 F. 25	691206	1400	37.57	4	50																

69															
	COD.	4 km/h	Euro	■	■	COD.	4 km/h	Euro	■	■	COD.	4 km/h	Euro	■	■
125x40	698603	350	25.48	4	70										
150x45	698504	750	37.55	4	70	697804	1100	112.05	4	70	698804	1100	55.22	4	70
200x45	698506	750	53.79	2	20	697806	1100	128.65	2	20	698806	1100	72.29	2	20

69																				
	COD.	4 km/h	Euro	■	■	COD.	4 km/h	Euro	■	■	COD.	4 km/h	Euro	■	■	COD.	4 km/h	Euro	■	■
100x38 F. 15	692122	600	26.91	12	300	694102	600	20.84	12	300	694902	200	33.33	12	100	695802	200	30.70	6	100
100x38 F. 20	692102	600	29.82	12	300	694102	600	20.84	12	300										
125x40	692103	700	33.37	6	180	694103	700	25.19	6	180	694903	220	42.58	6	70	695803	220	38.34	6	70
150x50	692104	1200	42.62	4	120	694104	1200	34.44	4	120	694904	300	58.71	4	70	695804	300	53.07	4	70
200x50 F. 20	692106	1400	60.66	4	50	694106	1400	51.66	4	50										
200x50 F. 25	692126	1400	60.87	4	50	694106	1400	51.66	4	50										

I RUOTE MONOLITICHE
IN GHISA MECCANICA

D EINTEILIGE
GÜßEISENRÄDER

GB CAST IRON
SOLID WHEELS

E RUEDAS MONO-BLOQUE
DE HIERRO FUNDIDO

F ROUES MONOLITHIQUES
EN FONTE MECANIQUE

RU ЛИТЫЕ КОЛЕСА ИЗ
МЕХАНИЧЕСКОГО ЧУГУНА

69

69																					
	COD.	4 km/h	Euro			COD.	4 km/h	Euro			COD.	4 km/h	Euro			COD.	4 km/h	Euro			
125x40	696203	350	53.03	4	70	696303	350	42.91	4	70											
150x50	696204	750	75.19	4	70	696304	750	56.61	4	70	697604	1100	131.11	4	70	697704	1100	74.28	4	70	
200x50	696206	750	97.30	2	20	696306	750	76.88	2	20	697606	1100	151.74	2	20	697706	1100	95.39	2	20	

Accessori (contropiastre, codoli, bloccaggi direzionali, parapiedi) : pag 142-144

Accessories (counter-plates, stems, directional locks, footguards): page 142-144

Accessoires (contre-platines, tiges, blocages directionnels, pare-pieds): page 142-144

Zubehöre (Gegenplatten, Zapfen, Richtungsfeststeller, Fußschutz): Seite 142-144

Accesorios (contraplacas, espigas, posicionadores direccionales, guardapié): pág 142-144

ДОПОЛНИТЕЛЬНЫЕ ПРИНАДЛЕЖНОСТИ (Панели, стержни, Фиксатор направления движения, Защиты для ног): стр. 142-144

I RUOTE IN GOMMA TERMOPLASTICA GRIGIA ANTITRACCIA, NUCLEO IN POLIPROPILENE

D RÄDER AUS GRAUEM THERMOPLASTISCHEM SPURLOSEM GUMMI, POLYPROPYLENFELGE

GB GREY NON-MARKING THERMOPLASTIC RUBBER WHEELS, POLYPROPYLENE CENTRE

E RUEDAS DE GOMA TERMOPLASTICA GRIS ANTI- HUELLA, NUCLEO DE POLIPROPILENO

F ROUES EN CAOUTCHOUC THERMOPLASTIQUE GRIS NON-TACHANT, CORPS EN POLYPROPYLENE

RU КОЛЕСА ИЗ ТЕРМОПЛАСТИЧНОЙ СЕРОЙ РЕЗИНЫ, НЕ ОСТАВЛЯЮЩЕЙ СЛЕДОВ С ОСНОВАНИЕМ ИЗ ПОЛИПРОПИЛЕНА

71



COD. **4 km/h** **Euro**

	COD.	4 km/h	Euro		
80x30	711101	70	2.46	12	300
100x30 Im 39	711132	100	3.07	12	300
125x35 Im 39	711133	120	4.59	12	180

71



COD. **4 km/h** **Euro** **SL**

COD. **4 km/h** **Euro** **SL**

COD. **4 km/h** **Euro** **SL**

	COD.	4 km/h	Euro			SL
80x30	715801	70	6.55	12	124	
100x30	715802	100	7.63	12	100	
125x35	715803	120	10.07	12	70	

71



COD. **4 km/h** **Euro** **SL**

COD. **4 km/h** **Euro** **SL**

	COD.	4 km/h	Euro			SL
80x30	716101	70	6.55	12	124	
100x30	716102	100	7.63	12	100	
125x35	716103	120	10.07	6	70	

I RUOTE IN GOMMA TERMOPLASTICA GRIGIA ANTITRACCIA, NUCLEO IN POLIPROPILENE

D RÄDER AUS GRAUEM THERMOPLASTISCHEM SPURLOSEM GUMMI, POLYPROPYLENFELGE





GB GREY NON-MARKING THERMOPLASTIC RUBBER WHEELS, POLYPROPYLENE CENTRE





E RUEDAS DE GOMA TERMOPLASTICA GRIS ANTI- HUELLA, NUCLEO DE POLIPROPILENO



F ROUES EN CAOUTCHOUC THERMOPLASTIQUE GRIS NON-TACHANT, CORPS EN POLYPROPYLENE

RU КОЛЕСА ИЗ ТЕРМОПЛАСТИЧНОЙ СЕРОЙ РЕЗИНЫ, НЕ ОСТАВЛЯЮЩЕЙ СЛЕДОВ С ОСНОВАНИЕМ ИЗ ПОЛИПРОПИЛЕНА

71

71																				
	COD.	4 km/h	Euro	■	■	COD.	4 km/h	Euro	■	■	COD.	4 km/h	Euro	■	■	COD.	4 km/h	Euro	■	■
80x30	711101	70	2.46	12	300	714201	70	8.88	12	124	715701	70	6.25	6	124	716601	70	15.50	12	124
100x30	711102	100	3.07	12	300	714202	100	9.49	12	100	715702	100	6.86	6	100	716602	100	16.11	12	100
125x35	711103	120	4.59	6	180	714203	120	13.80	12	70	715703	120	9.55	6	70	716603	120	20.42	12	70
150x35	711105	140	5.55	6	120	714204	140	14.76	6	70	715704	140	10.52	6	70	716604	140	21.38	6	70
150x45	711104	180	6.93	6	120	714211	180	23.02	6	70	715711	180	17.39	6	70	716611	180	33.58	6	70
200x50	711106	225	11.07	4	50	714206	225	28.15	2	20	715706	225	22.05	2	20	716606	225	38.71	2	20

71																				
	COD.	4 km/h	Euro	■	■	COD.	4 km/h	Euro	■	■	COD.	4 km/h	Euro	■	■	COD.	4 km/h	Euro	■	■
80x30	717401	70	8.88	12	124	716501	70	15.50	12	124	719201	70	13.74	12	124	719301	70	20.37	6	124
100x30	717402	100	9.49	12	100	716502	100	16.11	12	100	719202	100	14.36	12	100	719302	100	20.98	6	100
125x35	717403	120	13.80	6	70	716503	120	20.42	6	70	719203	120	18.66	6	70	719303	120	25.29	6	70
150x35	717404	140	14.76	6	70	716504	140	21.38	6	70										
150x45	717411	180	23.02	6	70	716511	180	33.58	6	70										
200x50	717406	225	28.15	2	20	716506	225	38.71	2	20										

71	 INOX					 INOX					 INOX										
	COD.	4 km/h	Euro	■	■	COD.	4 km/h	Euro	■	■	COD.	4 km/h	Euro	■	■						
80x30	714401	70	25.85	12	62	715301	70	15.12	6	62	716701	70	38.24	12	62						
100x30	714402	100	26.46	12	50	715302	100	15.73	6	50	716702	100	38.85	12	50						
125x35	714403	120	32.27	12	36	715303	120	20.12	6	36	716703	120	44.66	12	36						
150x35	714404	140	33.23	6	36	715304	140	21.08	6	36	716704	140	45.62	6	36						
150x45	714411	180	57.65	6	36	715311	180	37.54	6	36	716711	180	76.11	6	36						
200x50	714406	225	67.15	2	10	715306	225	44.77	2	10	716706	225	85.62	2	10						

I RUOTE IN GOMMA TERMOPLASTICA GRIGIA ANTITRACCIA, NUCLEO IN POLIPROPILENE

D RÄDER AUS GRAUEM THERMOPLASTISCHEM SPURLOSEM GUMMI, POLYPROPYLENFELGE

GB GREY NON-MARKING THERMOPLASTIC RUBBER WHEELS, POLYPROPYLENE CENTRE

E RUEDAS DE GOMA TERMOPLASTICA GRIS ANTI- HUELLA, NUCLEO DE POLIPROPILENO

F ROUES EN CAOUTCHOUC THERMOPLASTIQUE GRIS NON-TACHANT, CORPS EN POLYPROPYLENE

RU КОЛЁСА ИЗ ТЕРМОПЛАСТИЧНОЙ СЕРОЙ РЕЗИНЫ, НЕ ОСТАВЛЯЮЩЕЙ СЛЕДОВ С ОСНОВАНИЕМ ИЗ ПОЛИПРОПИЛЕНА

71	INOX					INOX														
	COD.	4 km/h	Euro	■	■	COD.	4 km/h	Euro	■	■										
80x30	717901	70	25.85	12	62	718801	70	38.24	12	62										
100x30	717902	100	26.46	12	50	718802	100	38.85	12	50										
125x35	717903	120	32.27	6	36	718803	120	44.66	6	36										
150x35	717904	140	33.23	6	36	718804	140	45.62	6	36										
150x45	717911	180	57.65	6	36	718811	180	76.11	6	36										
200x50	717906	225	67.15	2	10	718806	225	85.62	2	10										

71																				
	COD.	4 km/h	Euro	■	■	COD.	4 km/h	Euro	■	■	COD.	4 km/h	Euro	■	■	COD.	4 km/h	Euro	■	■
80x30	713101	70	3.81	12	300	714501	70	10.23	12	124	715901	70	7.60	6	124	716621	70	16.85	12	124
100x30	713102	100	4.42	12	300	714502	100	10.84	12	100	715902	100	8.21	6	100	716622	100	17.46	12	100
125x35	713103	120	6.03	6	180	714503	120	15.25	12	70	715903	120	11.00	6	70	716623	120	21.87	12	70
150x35	713105	140	7.00	6	120	714504	140	16.21	6	70	715904	140	11.96	6	70	716624	140	22.83	6	70
150x45	713104	180	8.38	6	120	714511	180	24.47	6	70	715911	180	18.84	6	70	716631	180	35.02	6	70
200x50	713106	225	13.14	4	50	714506	225	30.22	2	20	715906	225	24.12	2	20	716626	225	40.78	2	20

71																				
	COD.	4 km/h	Euro	■	■	COD.	4 km/h	Euro	■	■										
80x30	717801	70	10.23	12	124	716521	70	16.85	12	124										
100x30	717802	100	10.84	12	100	716522	100	17.46	12	100										
125x35	717803	120	15.25	6	70	716523	120	21.87	6	70										
150x35	717804	140	16.21	6	70	716524	140	22.83	6	70										
150x45	717811	180	24.47	6	70	716531	180	35.02	6	70										
200x50	717806	225	30.22	2	20	716526	225	40.78	2	20										

I RUOTE IN GOMMA TERMOPLASTICA GRIGIA ANTITRACCIA, NUCLEO IN POLIPROPILENE





D RÄDER AUS GRAUEM THERMOPLASTISCHEM SPURLOSEM GUMMI, POLYPROPYLENFELGE



GB GREY NON-MARKING THERMOPLASTIC RUBBER WHEELS, POLYPROPYLENE CENTRE



E RUEDAS DE GOMA TERMOPLASTICA GRIS ANTI- HUELLA, NUCLEO DE POLIPROPILENO

F ROUES EN CAOUTCHOUC THERMOPLASTIQUE GRIS NON-TACHANT, CORPS EN POLYPROPYLENE

RU КОЛЕСА ИЗ ТЕРМОПЛАСТИЧНОЙ СЕРОЙ РЕЗИНЫ, НЕ ОСТАВЛЯЮЩЕЙ СЛЕДОВ С ОСНОВАНИЕМ ИЗ ПОЛИПРОПИЛЕНА

71																				
	COD.	4 km/h	Euro	12	300	COD.	4 km/h	Euro	12	62	COD.	4 km/h	Euro	6	62	COD.	4 km/h	Euro	6	62
80x30	713201	70	5.26	12	300	714601	70	28.65	12	62	715601	70	17.92	6	62	716721	70	41.04	12	62
100x30	713202	100	5.87	12	300	714602	100	29.26	12	50	715602	100	18.53	6	50	716722	100	41.65	12	50
125x35	713203	120	8.52	6	180	714603	120	36.20	12	36	715603	120	24.05	6	36	716723	120	48.59	12	36
150x35	713205	140	9.48	6	120	714604	140	37.17	6	36	715604	140	25.02	6	36	716724	140	49.56	6	36
150x45	713204	180	10.87	6	120	714611	180	61.58	6	36	715611	180	41.47	6	36	716731	180	80.05	6	36
200x50	713206	225	17.28	4	50	714606	225	73.36	2	10	715606	225	50.98	2	10	716726	225	91.83	2	10

71																				
	COD.	4 km/h	Euro	12	300	COD.	4 km/h	Euro	12	62										
80x30	718001	70	28.65	12	62	718821	70	41.04	12	62										
100x30	718002	100	29.26	12	50	718822	100	41.65	12	50										
125x35	718003	120	36.20	6	36	718823	120	48.59	6	36										
150x35	718004	140	37.17	6	36	718824	140	49.56	6	36										
150x45	718011	180	61.58	6	36	718831	180	80.05	6	36										
200x50	718006	225	73.36	2	10	718826	225	91.83	2	10										

	 POLYAMIDE 6					 GALVANISED														
	COD.		Euro			COD.		Euro												
80x30	100501		1.79			100461		2.02												
100x30	100502		1.79			100462		2.20												
125x35	100503		1.79			100463		2.37												
150x35	100504		2.62																	
150x45	100514		2.62																	
200x50	100506		3.41																	

Per ordinare ruote e supporti montati con parafili, indicare il suffisso PF dopo il codice del complessivo ruota e supporto
 To order castors fitted with threadguards, please add "PF" to the complete unit code
 Pour commander les roues at roulettes avec pare-fils montés on doit indiquer après le code de la référence le suffixe "PF"
 Falls ein Fadenschutz gewünscht wird, bitte der Artikel-Nr. die Abkürzung "PF" hinzufügen
 Para solicitar un artículo con placa anti-hilos se necesita la sigla PF despues del código del artículo de la rueda con soporte
 Чтобы заказать колеса и опоры с нитезащитным устройством, необходимо указать аббревиатуру PF после кода узла колесо + опора.

I RUOTE IN GOMMA TERMOPLASTICA GRIGIA ANTITRACCIA, NUCLEO IN POLIPROPILENE

D RÄDER AUS GRAUEM THERMOPLASTISCHEM SPURLOSEM GUMMI, POLYPROPYLENFELGE

GB GREY NON-MARKING THERMOPLASTIC RUBBER WHEELS, POLYPROPYLENE CENTRE

E RUEDAS DE GOMA TERMOPLASTICA GRIS ANTI- HUELLA, NUCLEO DE POLIPROPILENO

F ROUES EN CAOUTCHOUC THERMOPLASTIQUE GRIS NON-TACHANT, CORPS EN POLYPROPYLENE

RU КОЛЁСА ИЗ ТЕРМОПЛАСТИЧНОЙ СЕРОЙ РЕЗИНЫ, НЕ ОСТАВЛЯЮЩЕЙ СЛЕДОВ С ОСНОВАНИЕМ ИЗ ПОЛИПРОПИЛЕНА

71



	COD.	4 km/h	Euro			COD.	4 km/h	Euro			COD.	4 km/h	Euro			COD.	4 km/h	Euro		
80x30	712201	70	5.46	12	300	714701	70	11.88	12	124	714801	70	9.25	6	124	714901	70	18.51	12	124
100x30	712202	100	6.08	12	300	714702	100	12.49	12	100	714802	100	9.86	6	100	714902	100	19.12	12	100
125x35	712203	120	7.59	6	180	714703	120	16.80	12	70	714803	120	12.55	6	70	714903	120	23.42	12	70
150x45	712204	180	13.14	6	120	714731	180	29.23	4	70	714811	180	23.60	4	70	714911	180	39.79	4	70
160x50	712210	200	14.49	6	120	714710	200	30.57	4	70	714810	200	24.94	4	70	714910	200	41.13	4	70
200x50	712206	225	17.28	4	50	714736	225	34.36	2	20	714806	225	28.26	2	20	714906	225	44.92	2	20

71



	COD.	4 km/h	Euro			COD.	4 km/h	Euro												
80x30	714301	70	11.88	12	124	715501	70	18.51	12	124										
100x30	714302	100	12.49	12	100	715502	100	19.12	12	100										
125x35	714303	120	16.80	12	70	715503	120	23.42	12	70										
150x45	714331	180	29.23	4	70	715511	180	39.79	4	70										
160x50	714310	200	30.57	4	70	715510	200	41.13	4	70										
200x50	714336	225	34.36	2	20	715506	225	44.92	2	20										

71



INOX



INOX



INOX



	COD.	4 km/h	Euro			COD.	4 km/h	Euro			COD.	4 km/h	Euro			COD.	4 km/h	Euro		
150x45	712404	180	20.91	6	120	715411	180	71.62	4	70	715011	180	51.51	4	70	716911	180	90.09	4	70
160x50	712410	200	22.25	6	120	715410	200	72.97	4	70	715010	200	52.86	4	70	716910	200	91.43	4	70
200x50	712406	225	25.05	4	50	715406	225	81.12	2	20	715036	225	58.75	2	20	716906	225	99.59	2	20

I RUOTE IN GOMMA TERMOPLASTICA GRIGIA ANTITRACCIA, NUCLEO IN POLIPROPILENE

D RÄDER AUS GRAUEM TERMOPLASTISCHEM SPURLOSEM GUMMI, POLYPROPYLENFELGE

GB GREY NON-MARKING THERMOPLASTIC RUBBER WHEELS, POLYPROPYLENE CENTRE

E RUEDAS DE GOMA TERMOPLASTICA GRIS ANTI- HUELLA, NUCLEO DE POLIPROPILENO

F ROUES EN CAOUTCHOUC THERMOPLASTIQUE GRIS NON-TACHANT, CORPS EN POLYPROPYLENE

RU КОЛЁСА ИЗ ТЕРМОПЛАСТИЧНОЙ СЕРОЙ РЕЗИНЫ, НЕ ОСТАВЛЯЮЩЕЙ СЛЕДОВ С ОСНОВАНИЕМ ИЗ ПОЛИПРОПИЛЕНА

71

71



INOX



INOX



NLX



NLX

COD.



4 km/h

Euro



COD.



4 km/h

Euro



150x45

716311

180

71.62

4

70

716541

180

90.09

4

70

160x50

716310

200

72.97

4

70

716510

200

91.43

4

70

200x50

716336

225

81.12

2

20

716546

225

99.59

2

20

Accessori (contropiastre, codoli, bloccaggi direzionali, parapiedi) : pag 142-144

Accessories (counter-plates, stems, directional locks, footguards): page 142-144

Accessoires (contre-platines, tiges, blocages directionnels, pare-pieds): page 142-144

Zubehöre (Gegenplatten, Zapfen, Richtungsfeststeller, Fußschutz): Seite 142-144

Accessorios (contraplacas, espigas, posicionadores direccionales, guardapié): pág 142-144

ДОПОЛНИТЕЛЬНЫЕ ПРИНАДЛЕЖНОСТИ (Панели, стержни, Фиксатор направления движения, Зашиты для ног): стр. 142-144

I RUOTE IN GOMMA SIGMA ELASTIC,
NUCLEO IN ALLUMINIO

D SIGMA ELASTIC GUMMI-RÄDER,
ALUKERN

GB SIGMA ELASTIC RUBBER WHEELS,
ALUMINIUM CENTRE

E RUEDAS DE GOMA SIGMA ELASTIC,
NUCLEO DE ALUMINIO

F ROUES EN CAOUTCHOUC SIGMA ELASTIC,
CORPS EN ALUMINIUM

RU КОЛЕСА ИЗ РЕЗИНЫ SIGMA ELASTIC,
ОСНОВАНИЕ ИЗ АЛЮМИНИЯ

72AL

72AL



COD.	4 km/h	Euro	NL		COD.	4 km/h	Euro	NL		COD.	4 km/h	Euro	NL		COD.	4 km/h	Euro	NL	
			■	■				■	■				■	■				■	■
100x40	721202	180	20.87	12 300	723102	180	14.80	12 300	724402	180	27.28	12 100	726202	180	24.65	6 100			
125x40 Im 40	721103	200	31.40	6 180	723003	200	23.23	6 180											
125x40 Im 50	721203	200	25.93	6 180	723103	200	17.75	6 180											
125x50	721213	230	31.71	6 180	723113	230	23.54	6 180	724413	230	45.50	4 70	726213	230	40.68	4 70			
160x50 F.20	721210	300	37.64	4 120	723104	300	29.47	4 120	724410	300	53.73	4 30	726210	300	48.10	4 30			
160x50 F.25	721110	300	37.85	4 120	723104	300	29.47	4 120											
180x50	721205	350	39.19	4 50	723105	350	31.01	4 50	724405	300	56.26	4 30	726205	300	50.16	4 30			
200x50 F. 20	721306	500	39.78	4 50	723126	500	31.60	4 50	724306	300	56.85	2 20	725206	300	50.75	2 20			
200x50 F. 20	721206	500	39.78	4 50	723106	500	30.77	4 50											
200x50 F. 25	721106	500	39.98	4 50	723106	500	30.77	4 50											
250x50	721208	500	67.89	1 24	723108	500	58.67	1 24											

72AL



COD.	4 km/h	Euro	NL		COD.	4 km/h	Euro	NL		COD.	4 km/h	Euro	M		COD.	4 km/h	Euro	M	
			■	■				■	■				■	■					
100x40	727302	180	33.91	12 100															
125x50	727313	230	52.12	4 70	724703	230	56.26	4 70											
160x50	727310	300	64.28	4 30	724710	300	68.42	4 30	724610	300	58.19	4 30	726210	300	48.10	4 30			
180x50	727305	300	66.82	4 30															
200x50	727106	300	67.41	2 20	724706	300	71.55	2 20	724506	500	61.77	2 20	725206	500	50.75	2 20			

72AL



COD.	4 km/h	Euro	M		COD.	4 km/h	Euro	P		COD.	4 km/h	Euro	P		COD.	4 km/h	Euro	P	
			■	■				■	■				■	■					
100x40					727602	180	39.91	6 100	728512	180	30.22	6 100							
125x50					727613	230	59.39	4 70	728523	230	43.18	4 70							
160x50	727910	300	70.58	4 30	727610	300	70.21	4 30	728514	300	51.64	4 30	727204	300	86.83	4 30			
180x50					727605	350	75.82	4 30	728515	350	55.40	4 30	727205	350	92.44	4 30			
200x50	727706	500	74.16	2 20	727516	500	76.41	2 20	728516	500	55.99	2 20	727206	500	93.03	2 20			
250x50					727518	500	109.80	1 8	728518	500	87.14	1 8	727208	500	126.41	1 8			

I RUOTE IN GOMMA SIGMA ELASTIC",
NUCLEO IN ALLUMINIO

D SIGMA ELASTIC GUMMI-RÄDER,
ALUKERN

GB SIGMA ELASTIC RUBBER WHEELS,
ALUMINIUM CENTRE

E RUEDAS DE GOMA SIGMA ELASTIC,
NUCLEO DE ALUMINIO

F ROUES EN CAOUTCHOUC SIGMA ELASTIC,
CORPS EN ALUMINIUM

RU КОЛЕСА ИЗ РЕЗИНЫ SIGMA ELASTIC,
ОСНОВАНИЕ ИЗ АЛЮМИНИЯ

72AL

72AL

	PT					PT					PT				
	COD.	4 km/h	Euro			COD.	4 km/h	Euro			COD.	4 km/h	Euro		
125x50	725503	230	63.01	4	70	728523	230	43.18	4	70	728203	230	79.06	2	70
160x50	725510	300	73.84	4	30	728514	300	51.64	4	30	728204	300	90.45	2	30
180x50	725505	350	79.76	4	30	728515	350	55.40	4	30	728205	350	96.63	4	30
200x50	725516	500	80.35	2	20	728516	500	55.99	2	20	728206	500	96.96	2	20

72AL

	EE MHD					EE MHD					EE MHD				
	COD.	4 km/h	Euro			COD.	4 km/h	Euro			COD.	4 km/h	Euro		
125x50	728303	230	114.17	2	70	728403	230	71.43	4	70	728603	230	145.09	2	70
160x50	728314	300	120.10	2	30	728414	300	77.36	2	30	728614	300	151.02	2	30
180x50	728305	350	121.64	2	30	728405	350	78.90	2	30	728605	350	152.56	1	30
200x50	728306	500	122.23	1	20	728406	500	79.49	1	20	728606	500	153.15	1	20
250x50	728307	500	209.54	1	8	728407	500	130.63	1	8	728607	500	240.45	1	8

72AL

	EEG MHD					EEG MHD					EEG HD					EEG HD						
	COD.	4 km/h	Euro			COD.	4 km/h	Euro			COD.	4 km/h	Euro			COD.	4 km/h	Euro				
100x(40+40)	728062	360	142.57	2	100	728162	360	96.90	2	100												
125x(40+40)	728063	400	175.96	2	70	728163	400	124.15	2	70												
160x(50+50)											728084	600	310.11	1	30	728184	600	175.03	1	30		
200x(50+50)											728086	1000	314.37	1	20	728186	1000	179.29	1	20		

I RUOTE IN GOMMA SIGMA ELASTIC,
NUCLEO IN ALLUMINIO

D SIGMA ELASTIC GUMMI-RÄDER,
ALUKERN











GB SIGMA ELASTIC RUBBER WHEELS,
ALUMINIUM CENTRE

E RUEDAS DE GOMA SIGMA ELASTIC,
NUCLEO DE ALUMINIO

F ROUES EN CAOUTCHOUC SIGMA ELASTIC,
CORPS EN ALUMINIUM

RU КОЛЕСА ИЗ РЕЗИНЫ SIGMA ELASTIC,
ОСНОВАНИЕ ИЗ АЛЮМИНИЯ

72_{AL}

72 _{AL}																				
				EES MHD				EES MHD				EES MHD								
				COD.	4 km/h			Euro	■ ■ ■ ■			COD.	4 km/h	Euro	■ ■ ■ ■	COD.	4 km/h	Euro	■ ■ ■ ■	
160x50	726304	300	242.26	2	16	726404	300	199.31	2	16	726504	300	283.66	2	16					
200x50	726306	500	244.39	1	10	726406	500	201.44	1	10	726506	500	285.79	1	10					
250x50	726308	500	328.71	1	8	726408	500	253.15	1	8	726508	500	370.11	1	8					

Accessori (contropiastre, codoli, bloccaggi direzionali, parapiedi): pag 142-144

Accessories (counter-plates, stems, directional locks, footguards): page 142-144

Accessoires (contre-platines, tiges, blocages directionnels, pare-pieds): page 142-144

Zubehöre (Gegenplatten, Zapfen, Richtungsfeststeller, Fußschutz): Seite 142-144

Accesorios (contraplacas, espigas, posicionadores direccionales, guardapié): pag 142-144

ДОПОЛНИТЕЛЬНЫЕ ПРИНАДЛЕЖНОСТИ (Панели, стержни, Фиксатор направления движения, Зашиты для ног): стр. 142-144

I RUOTE IN GOMMA SIGMA ELASTIC,
NUCLEO IN GHISA MECCANICA

D RÄDER AUS SIGMA ELASTIC GUMMI,
FELGE AUS GUSSEISEN



GB SIGMA ELASTIC RUBBER WHEELS,
CAST IRON CENTRE





E RUEDAS DE GOMA SIGMA ELASTIC,
NUCLEO DE HIERRO FUNDIDO

F ROUES EN CAOUTCHOUC SIGMA ELASTIC,
CORPS EN FONTE MECANIQUE

RU КОЛЁСА ИЗ ЭЛАСТИЧНОЙ РЕЗИНЫ SIGMA С
ОСНОВАНИЕМ ИЗ МЕХАНИЧЕСКОГО ЧУГУНА

72GH

72GH															
	COD.	4 km/h	Euro	■	■	COD.	4 km/h	Euro	■	■	COD.	4 km/h	Euro	■	■
125x50	722103	300	47.10	6	180	724103	300	38.93	6	180	724313	300	60.89	4	70
150x50 F.20	722104	400	55.11	4	120	724104	400	46.94	4	120	724304	300	71.20	2	70
150x50 F.25	722124	400	55.32	4	120	724104	400	46.94	4	120					
200x50	722106	500	64.50	4	50	724106	500	55.29	4	50	724336	300	81.58	2	20
200x75 Im 85	722126	700	88.47	2	50	724126	700	79.26	2	50					
250x75 Im 88	722108	800	130.28	1	24	724108	800	121.06	1	24					
300x85 F. 30	722109	950	196.04	1	12	724109	950	184.00	1	12					
300x85 F. 35	722129	950	196.35	1	12	724109	950	184.00	1	12					

72GH																				
	COD.	4 km/h	Euro	■	■	COD.	4 km/h	Euro	■	■	COD.	4 km/h	Euro	■	■	COD.	4 km/h	Euro	■	■
125x50	727113	300	67.51	4	70															
150x50	727124	300	81.75	2	70	724504	400	75.66	2	70	725204	400	65.57	2	70	727724	400	88.05	2	70
200x50	727126	300	92.14	2	20	724536	500	86.49	2	20	725236	500	75.47	2	20	727726	500	98.88	2	20

I RUOTE IN GOMMA SIGMA ELASTIC,
NUCLEO IN GHISA MECCANICA

D RÄDER AUS SIGMA ELASTIC GUMMI,
FELGE AUS GUSSEISEN

GB SIGMA ELASTIC RUBBER WHEELS,
CAST IRON CENTRE

E RUEDAS DE GOMA SIGMA ELASTIC,
NUCLEO DE HIERRO FUNDIDO

F ROUES EN CAOUTCHOUC SIGMA ELASTIC,
CORPS EN FONTE MECANIQUE

RU КОЛЁСА ИЗ ЭЛАСТИЧНОЙ РЕЗИНЫ SYGMA С
ОСНОВАНИЕМ ИЗ МЕХАНИЧЕСКОГО ЧУГУНА

72GH

72GH



COD.	4 km/h	Euro	P		COD.	4 km/h	Euro	P		COD.	4 km/h	Euro	P	
			■	■				■	■				■	■

125x50	727513	300	74.78	4	70	728513	300	58.57	4	70					
150x50	727504	400	87.69	2	70	728504	400	69.11	2	70	727224	400	104.30	2	70
200x50	727506	500	101.14	2	20	728506	500	80.72	2	20	727226	500	117.75	2	20

72GH



COD.	4 km/h	Euro	EP		COD.	4 km/h	Euro	EP		COD.	4 km/h	Euro	EP	
			■	■				■	■				■	■

150x50	727814	400	143.61	2	70	728814	400	86.77	2	70	727324	400	160.22	2	70
200x50	727816	500	155.58	2	20	728816	500	99.23	2	20	727326	500	172.19	2	20
200x75	727806	700	236.19	1	20	728806	700	158.90	1	20					
250x75	727808	800	277.99	1	8	728808	800	200.71	1	8					

I RUOTE IN GOMMA SIGMA ELASTIC,
NUCLEO IN GHISA MECCANICA

D RÄDER AUS SIGMA ELASTIC GUMMI,
FELGE AUS GUSSEISEN

GB SIGMA ELASTIC RUBBER WHEELS,
CAST IRON CENTRE

E RUEDAS DE GOMA SIGMA ELASTIC,
NUCLEO DE HIERRO FUNDIDO

F ROUES EN CAOUTCHOUC SIGMA ELASTIC,
CORPS EN FONTE MECANIQUE

RU КОЛЁСА ИЗ ЭЛАСТИЧНОЙ РЕЗИНЫ СИГМА С
ОСНОВАНИЕМ ИЗ МЕХАНИЧЕСКОГО ЧУГУНА

72GH

72GH



	EE MHD					EE MHD					EE MHD				
	COD.	4 km/h	Euro	■	■	COD.	4 km/h	Euro	■	■	COD.	4 km/h	Euro	■	■
125x50	729303	300	129.56	2	70	729403	300	86.82	2	70	729603	300	160.48	2	70
150x50	729304	400	137.57	2	70	729404	400	94.83	2	70	729604	400	168.49	2	70
200x50	729306	500	146.96	1	20	729406	500	104.21	1	20	729606	500	177.88	1	20

72GH



	EE HD					EE HD					EE HD				
	COD.	4 km/h	Euro	■	■	COD.	4 km/h	Euro	■	■	COD.	4 km/h	Euro	■	■
200x75	729316	700	228.84	1	20	729416	700	154.42	1	20	729616	700	259.75	1	20
250x75	729307	800	270.64	1	8	729407	800	196.23	1	8	729607	800	301.56	1	8
300x85	729308	950	365.25	1	4	729408	950	273.27	1	4	729608	950	396.17	1	4

72GH



	EEG HD					EEG HD									
	COD.	4 km/h	Euro	■	■	COD.	4 km/h	Euro	■	■	COD.	4 km/h	Euro	■	■
150x(50+50)	728074	800	345.05	1	70	728174	800	209.97	1	70					
200x(50+50)	728066	1000	363.41	1	20	728166	1000	228.33	1	20					
200x(50+50)PG	728076	1000	375.69	1	20	728176	1000	240.62	1	20					

72GH



	EES MHD					EES MHD					EES MHD				
	COD.	4 km/h	Euro	■	■	COD.	4 km/h	Euro	■	■	COD.	4 km/h	Euro	■	■
150x50	725704	400	262.84	2	16	725804	400	216.78	2	16	726004	400	304.24	2	16
200x50	725706	500	268.91	1	10	725806	500	225.96	1	10	726006	500	310.31	1	10

I RUOTE IN GOMMA SILICONICA PER ALTA TEMPERATURA, NUCLEO IN ALLUMINIO

D HITZBESTÄNDIGE RÄDER AUS SILIKONGUMMI, ALUKERN























































GB SILICONE RUBBER WHEELS FOR HIGH TEMPERATURES, ALUMINIUM CENTRE

E RUEDAS DE GOMA SILICONICA PARA ALTAS TEMPERATURAS, NUCLEO DE ALUMINIO

F ROUES EN CAOUTCHOUC SILICONIQUE POUR HAUTES TEMPERATURES, CORPS EN ALUMINIUM

RU КОЛЕСА ИЗ СИЛИКОНОВОЙ РЕЗИНЫ КРАСНОГО ЦВЕТА ДЛЯ ВЫСОКИХ ТЕМПЕРАТУР, ОСНОВАНИЕ ИЗ АЛЮМИНИЯ

72Gs

72Gs																				
																				
	COD.  4 km/h Euro  	COD.  4 km/h Euro  	COD.  4 km/h Euro  	COD.  4 km/h Euro  																
100x40	722152	80	33.76	12	300	724452PF	80	42.66	12	100	726252PF	80	40.03	12	100	727152PF	80	49.29	12	100
72Gs																				
																				
	COD.  4 km/h Euro  	COD.  4 km/h Euro  	COD.  4 km/h Euro  	COD.  4 km/h Euro  																
100x40	727352PF	80	42.66	12	100	727452PF	80	49.29	12	100	724462PF	80	59.64	12	50	726262PF	80	48.90	12	50
72Gs																				
																				
	COD.  4 km/h Euro  	COD.  4 km/h Euro  	COD.  4 km/h Euro  																	
100x40	727162PF	80	72.03	12	50	727362PF	80	59.64	12	50	727462PF	80	72.03	12	50					

Accessori (contropiastre, codoli, bloccaggi direzionali, parapiedi) : pag 142-144

Accessories (counter-plates, stems, directional locks, footguards): page 142-144

Accessoires (contre-platines, tiges, blocages directionnels, pare-pieds): page 142-144

Zubehöre (Gegenplatten, Zapfen, Richtungsfeststeller, Fußschutz): Seite 142-144

Accesorios (contraplacas, espigas, posicionadores direccionales, guardapié): pág 142-144

ДОПОЛНИТЕЛЬНЫЕ ПРИНАДЛЕЖНОСТИ (Панели, стержни, Фиксатор направления движения, Защиты для ног): стр. 142-144

I RUOTE IN GOMMA SIGMA ELASTIC,
NUCLEO IN POLIAMMIDE 6

D SIGMA ELASTIC GUMMI- RÄDER,
KERN AUS POLYAMID 6

GB SIGMA ELASTIC RUBBER WHEELS,
POLYAMIDE 6 CENTRE

E RUEDAS DE GOMA SIGMA ELASTIC,
NUCLEO DE POLIAMIDA 6

F ROUES EN CAOUTCHOUC SIGMA ELASTIC,
CORPS EN POLYAMIDE 6

RU КОЛЕСА ИЗ РЕЗИНЫ SIGMA ELASTIC,
ОСНОВАНИЕ ИЗ ПОЛИАМИДА 6

73

73



	NL					NL					NL					NL									
	COD.	4 km/h	Euro	■	■	COD.	4 km/h	Euro	■	■	COD.	4 km/h	Euro	■	■	COD.	4 km/h	Euro	■	■	COD.	4 km/h	Euro	■	■
100x40	731102	150	11.04	12	300	735002	150	17.46	12	100	735102	150	14.83	6	100	735202	150	24.08	12	100					
125x40	731103	230	13.65	6	180	735003	220	22.86	12	70	735103	220	18.62	6	70	735203	220	29.49	12	70					
160x50	731104	300	21.89	6	120	735004	300	37.97	4	30	735104	300	32.34	4	30	735204	300	48.53	4	30					
180x50	731105	350	23.30	4	50	735005	300	40.38	4	30	735105	300	34.27	4	30	735205	300	50.93	4	30					
200x50	731106	450	24.32	4	50	735006	300	41.40	2	20	735106	300	35.29	2	20	735206	300	51.96	2	20					

73



	NL					NL					NL					NL									
	COD.	4 km/h	Euro	■	■	COD.	4 km/h	Euro	■	■	COD.	4 km/h	Euro	■	■	COD.	4 km/h	Euro	■	■	COD.	4 km/h	Euro	■	■
100x40	737702	150	17.46	12	100	738202	150	24.08	12	100	738702	150	20.39	12	100	738802	150	27.01	12	100					
125x40	737703	220	22.86	6	70	738203	220	29.49	6	70	738703	220	25.79	6	70	738803	220	32.42	6	70					
160x50	737704	300	37.97	4	30	738204	300	48.53	4	30	738704	300	45.30	4	30	738804	300	55.86	4	30					
180x50	737705	300	40.38	4	30	738205	300	50.93	4	30	738705	300	47.70	4	30	738805	300	58.26	4	30					
200x50	737706	300	41.40	2	20	738206	300	51.96	2	20	738706	300	48.73	2	20	738806	300	59.28	2	20					

73



	M					M					M														
	COD.	4 km/h	Euro	■	■	COD.	4 km/h	Euro	■	■	COD.	4 km/h	Euro	■	■										
160x50	736904	300	42.44	4	30	735104	300	32.34	4	30	737604	300	54.82	4	30										
200x50	736906	450	46.32	2	20	735106	450	35.29	2	20	737606	450	58.71	2	20										

I RUOTE IN GOMMA SIGMA ELASTIC,
NUCLEO IN POLIAMMIDE 6

















D SIGMA ELASTIC GUMMI- RÄDER,
KERN AUS POLYAMID 6

















GB SIGMA ELASTIC RUBBER WHEELS,
POLYAMIDE 6 CENTRE

















E RUEDAS DE GOMA SIGMA ELASTIC,
NUCLEO DE POLIAMIDA 6

F ROUES EN CAOUTCHOUC SIGMA ELASTIC,
CORPS EN POLYAMIDE 6

RU КОЛЕСА ИЗ РЕЗИНЫ SIGMA ELASTIC,
ОСНОВАНИЕ ИЗ ПОЛИАМИДА 6

73																		
																		
	COD.	 4 km/h	Euro	 	COD.	 4 km/h	Euro	 	COD.	 4 km/h	Euro	 						
100x40	736002	150	30.09	12 100	736102	150	20.40	6 100	736202	150	36.71	12 100						
125x40	736003	230	33.32	12 70	736103	230	23.19	6 70	736203	230	39.94	12 70						

73																		
																		
	COD.	 4 km/h	Euro	 	COD.	 4 km/h	Euro	 	COD.	 4 km/h	Euro	 						
160x50	736004	300	54.46	4 30	736104	300	35.88	4 30	736204	300	71.07	4 30						
180x50	736005	350	59.94	4 30	736105	350	39.52	4 30	736205	350	76.55	4 30						
200x50	736006	450	60.96	2 20	736106	450	40.54	2 20	736206	450	77.57	2 20						

73				INOX	INOX	INOX												
																		
	COD.	 4 km/h	Euro	 	COD.	 4 km/h	Euro	 	COD.	 4 km/h	Euro	 						
100x40	739402	150	34.43	12 50	739502	150	23.70	6 50	739602	150	46.82	12 50						
125x40	739403	220	41.34	12 36	739503	220	29.19	6 36	739603	220	53.73	12 36						
160x50	739404	300	72.61	4 16	739504	300	52.50	4 16	739604	300	91.07	4 16						
200x50	739406	300	80.40	2 10	739506	300	58.02	2 10	739606	300	98.86	2 10						

	 GALVANISED	 INOX																
	COD.	Euro	COD.	Euro														
100x40	100012	2.48																
125x40	100040	4.08																
180x50	100034	7.75																
200x50	100495	2.66			100237	6.99												

I RUOTE IN GOMMA SIGMA ELASTIC,
NUCLEO IN POLIAMMIDE 6

D SIGMA ELASTIC GUMMI- RÄDER,
KERN AUS POLYAMID 6













GB SIGMA ELASTIC RUBBER WHEELS,
POLYAMIDE 6 CENTRE

















E RUEDAS DE GOMA SIGMA ELASTIC,
NUCLEO DE POLIAMIDA 6









F ROUES EN CAOUTCHOUC SIGMA ELASTIC,
CORPS EN POLYAMIDE 6

RU КОЛЕСА ИЗ РЕЗИНЫ SIGMA ELASTIC,
ОСНОВАНИЕ ИЗ ПОЛИАМИДА 6

73

73		INOX						INOX						INOX				
		PX					PX					PX						
	COD.		4 km/h	Euro			COD.		4 km/h	Euro			COD.		4 km/h	Euro		
160x50	737004	300	131.00	4	16	737104	300	71.92	4	16	737204	300	165.13	4	16			
180x50	737005	350	135.94	4	16	737105	350	76.45	4	16	737205	350	170.07	4	16			
200x50	737006	450	136.96	2	10	737106	450	77.47	2	10	737206	450	171.10	2	10			

73								NL						NL						NL				
							NL					NL					NL							
	COD.		4 km/h	Euro			COD.		4 km/h	Euro			COD.		4 km/h	Euro			COD.		4 km/h	Euro		
100x40	733102	150	13.32	12	300	735302	150	19.74	12	100	735402	150	17.11	6	100	735502	150	26.36	12	100				
125x40	733103	230	16.55	6	180	735303	220	25.76	12	70	735403	220	21.52	6	70	735503	220	32.39	12	70				
160x50	733104	300	25.20	6	120	735304	300	41.29	4	30	735404	300	35.66	4	30	735504	300	51.84	4	30				
180x50	733105	350	26.61	4	50	735305	300	43.69	4	30	735405	300	37.58	4	30	735505	300	54.24	4	30				
200x50	733106	450	27.63	4	50	735306	300	44.71	2	20	735406	300	38.61	2	20	735506	300	55.27	2	20				

73								NL														
							NL															
	COD.		4 km/h	Euro			COD.		4 km/h	Euro												
100x40	737802	150	19.74	12	100	738302	150	26.36	12	100												
125x40	737803	220	25.76	6	70	738303	220	32.39	6	70												
160x50	737804	300	41.29	4	30	738304	300	51.84	4	30												
180x50	737805	300	43.69	4	30	738305	300	54.24	4	30												
200x50	737806	300	44.71	2	20	738306	300	55.27	2	20												

I RUOTE IN GOMMA SIGMA ELASTIC,
NUCLEO IN POLIAMMIDE 6

D SIGMA ELASTIC GUMMI- RÄDER,
KERN AUS POLYAMID 6

GB SIGMA ELASTIC RUBBER WHEELS,
POLYAMIDE 6 CENTRE

E RUEDAS DE GOMA SIGMA ELASTIC,
NUCLEO DE POLIAMIDA 6

F ROUES EN CAOUTCHOUC SIGMA ELASTIC,
CORPS EN POLYAMIDE 6

RU КОЛЕСА ИЗ РЕЗИНЫ SIGMA ELASTIC,
ОСНОВАНИЕ ИЗ ПОЛИАМИДА 6

73



COD. 4 km/h Euro

COD. 4 km/h Euro

COD. 4 km/h Euro

160x50

738904

300

45.75

4

30

735404

300

35.66

4

30

739004

300

58.14

4

30

200x50

738906

450

49.63

2

20

735406

450

38.61

2

20

739006

450

62.02

2

20

73



COD. 4 km/h Euro

COD. 4 km/h Euro

COD. 4 km/h Euro

100x40

736302

150

32.36

12

100

736402

150

22.68

6

100

736502

150

38.99

12

100

125x40

736303

230

36.21

12

70

736403

230

26.09

6

70

736503

230

42.84

12

70

73

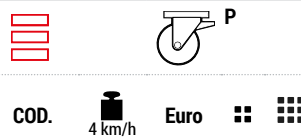
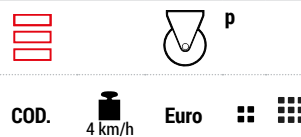
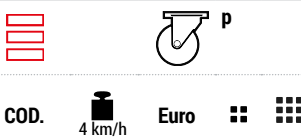

COD. 4 km/h Euro

COD. 4 km/h Euro

COD. 4 km/h Euro

160x50

736304

300

57.77

4

30

736404

300

39.20

4

30

736504

300

74.39

4

30

180x50

736305

350

63.25

4

30

736405

350

42.83

4

30

736505

350

79.86

4

30

200x50

736306

450

64.27

2

20

736406

450

43.85

2

20

736506

450

80.89

2

20

I RUOTE IN GOMMA SIGMA ELASTIC,
NUCLEO IN POLIAMMIDE 6

D SIGMA ELASTIC GUMMI- RÄDER,
KERN AUS POLYAMID 6





















GB SIGMA ELASTIC RUBBER WHEELS,
POLYAMIDE 6 CENTRE

















E RUEDAS DE GOMA SIGMA ELASTIC,
NUCLEO DE POLIAMIDA 6





















F ROUES EN CAOUTCHOUC SIGMA ELASTIC,
CORPS EN POLYAMIDE 6

RU КОЛЕСА ИЗ РЕЗИНЫ SIGMA ELASTIC,
ОСНОВАНИЕ ИЗ ПОЛИАМИДА 6

73

73						 INOX					 INOX					 INOX										
						COD.		Euro			COD.		Euro			COD.		Euro			COD.		Euro			
100x40	733202	150	14.77	12	300	739702	150	38.16	12	50	739802	150	27.43	6	50	739902	150	50.55	12	50						
125x40	733203	230	19.65	6	180	739703	220	47.34	12	36	739803	220	35.19	6	36	739903	220	59.73	12	36						
160x50	733204	300	29.14	6	120	739704	300	79.85	4	16	739804	300	59.74	4	16	739904	300	98.31	4	16						
180x50	733205	350	30.54	4	50																					
200x50	733206	450	31.57	4	50	739706	300	87.64	2	10	739806	300	65.27	2	10	739906	300	106.11	2	10						

73																									
						COD.		Euro			COD.		Euro			COD.		Euro							
160x50	737304	300	138.24	4	16	737404	300	79.17	4	16	737504	300	172.38	4	16										
180x50	737305	350	143.18	4	16	737405	350	83.69	4	16	737505	350	177.32	4	16										
200x50	737306	450	144.21	2	10	737406	450	84.71	2	10	737506	450	178.34	2	10										

73																									
						COD.		Euro			COD.		Euro			COD.		Euro			COD.		Euro		
100x40	732102	150	19.56	12	300	734102	150	13.50	12	300	735602	150	25.98	12	100	735702	150	23.35	6	100					
125x40	732103	230	21.74	6	180	734103	230	13.56	6	180	735603	220	30.95	12	70	735703	220	26.70	6	70					
160x50 F. 20	732104	300	31.33	6	120	734104	300	23.15	6	120	735604	300	47.41	4	30	735704	300	41.78	4	30					
160x50 F. 25	732114	300	31.54	6	120	734104	300	23.15	6	120															
180x50 F. 20	732105	350	33.96	4	50	734105	350	25.78	4	50	735605	300	51.04	4	30	735705	300	44.93	4	30					
180x50 F. 25	732115	350	34.17	4	50	734105	350	25.78	4	50															
200x50 F. 20	732106	450	36.23	4	50	734106	450	28.05	4	50	735606	300	53.30	2	20	735706	300	47.20	2	20					
200x50 F. 25	732116	450	36.43	4	50	734106	450	28.05	4	50															

I RUOTE IN GOMMA SIGMA ELASTIC,
NUCLEO IN POLIAMMIDE 6

D SIGMA ELASTIC GUMMI- RÄDER,
KERN AUS POLYAMID 6











GB SIGMA ELASTIC RUBBER WHEELS,
POLYAMIDE 6 CENTRE











E RUEDAS DE GOMA SIGMA ELASTIC,
NUCLEO DE POLIAMIDA 6











F ROUES EN CAOUTCHOUC SIGMA ELASTIC,
CORPS EN POLYAMIDE 6











RU КОЛЕСА ИЗ РЕЗИНЫ SIGMA ELASTIC,
ОСНОВАНИЕ ИЗ ПОЛИАМИДА 6

73

73															
															
	COD.	4 km/h	Euro	■	■	COD.	4 km/h	Euro	■	■	COD.	4 km/h	Euro	■	■
100x40	735802	150	32.60	12	100	735902	150	25.98	12	100	738402	150	32.60	12	100
125x40	735803	220	37.57	12	70	735903	220	30.95	6	70	738403	220	37.57	6	70
160x50	735804	300	57.97	4	30	735904	300	47.41	4	30	738404	300	57.97	4	30
180x50	735805	300	61.59	4	30	735905	300	51.04	4	30	738405	300	61.59	4	30
200x50	735806	300	63.86	2	20	735906	300	53.30	2	20	738406	300	63.86	2	20

73															
															
	COD.	4 km/h	Euro	■	■	COD.	4 km/h	Euro	■	■	COD.	4 km/h	Euro	■	■
160x50	739104	300	51.87	4	30	735704	300	41.78	4	30	739204	300	64.26	4	30
200x50	739106	450	58.22	2	20	735706	450	47.20	2	20	739206	450	70.61	2	20

73															
															
	COD.	4 km/h	Euro	■	■	COD.	4 km/h	Euro	■	■	COD.	4 km/h	Euro	■	■
100x40	736602	150	38.61	12	100	736702	150	28.92	6	100	736802	150	45.23	12	100
125x40	736603	230	41.40	12	70	736703	230	31.28	6	70	736803	230	48.02	12	70

73															
															
	COD.	4 km/h	Euro	■	■	COD.	4 km/h	Euro	■	■	COD.	4 km/h	Euro	■	■
160x50	736604	300	63.90	4	30	736704	300	45.32	4	30	736804	300	80.51	4	30
180x50	736605	350	70.60	4	30	736705	350	50.18	4	30	736805	350	85.35	4	30
200x50	736606	450	72.86	2	20	736706	450	52.44	2	20	736806	450	89.48	2	20

I RUOTE IN GOMMA ELASTICA,
NUCLEO IN POLIAMMIDE 6

D ELASTIK-VOLLGUMMI-RÄDER,
KERN AUS POLYAMID

GB ELASTIC RUBBER WHEELS,
POLYAMIDE 6 CENTRE

E RUEDAS DE GOMA ELASTICA,
NUCLEO DE POLIAMIDA 6

F ROUES EN CAOUTCHOUC ELASTIQUE,
CORPS EN POLYAMIDE 6

RU КОЛЕСА ИЗ ЭЛАСТИЧНОЙ РЕЗИНЫ,
ОСНОВАНИЕ ИЗ ПОЛИАМИДА 6

73_{AE}

73_{AE}



COD.	4 km/h	Euro	NL		COD.	4 km/h	Euro	NL		COD.	4 km/h	Euro	NL		COD.	4 km/h	Euro	NL		
			■	■				■	■				■	■				■	■	■
100x36	731102AE	150	6.80	12 300	735002AE	150	13.22	12 100	735102AE	150	10.59	6 100	735202AE	150	19.84	12 100				
125x36	731103AE	200	8.42	6 180	735003AE	200	17.65	12 70	735103AE	200	13.39	6 70	735203AE	200	24.27	12 70				
160x48	731104AE	300	14.82	6 120	735004AE	300	30.91	4 30	735104AE	300	25.27	4 30	735204AE	300	41.46	4 30				
200x48	731106AE	350	19.11	4 50	735006AE	300	36.18	2 20	735106AE	300	30.08	2 20	735206AE	300	46.74	2 20				

73_{AE}



COD.	4 km/h	Euro	P		COD.	4 km/h	Euro	P		COD.	4 km/h	Euro	P		COD.	4 km/h	Euro	P		
			■	■				■	■				■	■				■	■	
100x36	736002AE	150	25.84	12 100	736102AE	150	16.16	6 100	736202AE	150	32.47	12 100								
125x36	736003AE	200	28.09	12 70	736103AE	200	17.97	6 70	736203AE	200	34.71	12 70								

73_{AE}



COD.	4 km/h	Euro	P		COD.	4 km/h	Euro	P		COD.	4 km/h	Euro	P		COD.	4 km/h	Euro	P		
			■	■				■	■				■	■				■	■	
160x48	736004AE	300	47.39	4 30	736104AE	300	28.81	4 30	736204AE	300	64.00	4 30								
200x48	736006AE	350	55.75	2 20	736106AE	350	35.32	2 20	736206AE	350	72.36	2 20								

I RUOTE IN GOMMA ELASTICA,
NUCLEO IN POLIAMMIDE 6

D ELASTIK-VOLLGUMMI-RÄDER,
KERN AUS POLYAMID

GB ELASTIC RUBBER WHEELS,
POLYAMIDE 6 CENTRE

E RUEDAS DE GOMA ELASTICA,
NUCLEO DE POLIAMIDA 6

F ROUES EN CAOUTCHOUC ELASTIQUE,
CORPS EN POLYAMIDE 6

RU КОЛЕСА ИЗ ЭЛАСТИЧНОЙ РЕЗИНЫ,
ОСНОВАНИЕ ИЗ ПОЛИАМИДА 6

73_{AE}

73_{AE}



COD.	4 km/h	Euro	NL		COD.	4 km/h	Euro	NL		COD.	4 km/h	Euro	NL		COD.	4 km/h	Euro	NL		
			■	■				■	■				■	■				■	■	
100x36	732102AE	150	10.96	12	300	735602AE	150	17.07	12	100	735702AE	150	14.75	6	100	735802AE	150	23.69	12	100
125x36	732103AE	200	12.56	6	180	735603AE	200	21.78	12	70	735703AE	200	17.53	6	70	735803AE	200	28.40	12	70
160x48	732104AE	300	20.70	6	120	735604AE	300	36.78	4	30	735704AE	300	31.15	4	30	735804AE	300	47.34	4	30
200x48	732106AE	350	24.95	4	50	735606AE	300	42.03	2	20	735706AE	300	35.92	2	20	735806AE	300	52.59	2	20

73_{AE}



COD.	4 km/h	Euro	NL		COD.	4 km/h	Euro	P		COD.	4 km/h	Euro	P		COD.	4 km/h	Euro	P	
			■	■				■	■				■	■				■	■
100x36					736602AE	150	30.00	12	100	736702AE	150	20.32	6	100	736802AE	150	36.63	12	100
125x36					736603AE	200	32.23	12	70	736703AE	200	22.11	6	70	736803AE	200	38.85	12	70
160x48	734804AE	150	51.48	4	30														
200x48	734806AE	200	56.73	2	20														

73_{AE}



COD.	4 km/h	Euro	P		COD.	4 km/h	Euro	P		COD.	4 km/h	Euro	P		
			■	■				■	■				■	■	
160x48	736604AE	300	53.27	4	30	736704AE	300	34.69	4	30	736804AE	300	69.88	4	30
200x48	736606AE	350	61.59	2	20	736706AE	350	41.17	2	20	736806AE	350	78.20	2	20

Accessori (contropiastre, codoli, bloccaggi direzionali, parapiedi) : pag 142-144

Accessories (counter-plates, stems, directional locks, footguards): page 142-144

Accessoires (contre-platines, tiges, blocages directionnels, pare-pieds): page 142-144

Zubehöre (Gegenplatten, Zapfen, Richtungsfeststeller, Fußschutz): Seite 142-144

Accesorios (contraplacas, espigas, posicionadores direccionales, guardapié): pág 142-144

ДОПОЛНИТЕЛЬНЫЕ ПРИНАДЛЕЖНОСТИ (Панели, стержни, Фиксатор направления движения, Защиты для ног): стр. 142-144

I RULLI TRANSPALLET IN VULKOLLAN®,
NUCLEO IN ACCIAIO

D VULKOLLAN® GABELHUBWAGEN-ROLLEN,
STAHLKERN

GB VULKOLLAN® TRANSPALLET ROLLERS,
STEEL CENTRE

E RODILLOS TRANSPALETAS DE VULKOLLAN®,
NUCLEO DE ACERO









F GALETS TRANSPALETES EN VULKOLLAN®,
CORPS EN ACIER

RU РОЛИКИ ГИДРАВЛИЧЕСКИХ ТЕЛЕЖЕК ИЗ
ВУЛКОЛАНА®, ОСНОВАНИЕ ИЗ СТАЛИ

74





74



																				
	COD.	 4 km/h	Euro			COD.	 4 km/h	Euro												
80x70	742202	700	53.46	10	50	744202	700	43.93	10	50										
80x90	742105	900	59.11	10	50	744105	900	49.58	10	50										
85x40	742121	400	45.93	10	50	744121	400	36.40	10	50										
85x70	742122	700	56.41	10	50	744122	700	46.88	10	50										
85x80 F. 20	742123	800	64.51	10	50	744123	800	54.98	10	50										
85x80 F. 25	742224	800	68.09	10	50	744224	800	55.32	10	50										
85x90	742125	900	66.86	10	50	744125	900	57.33	10	50										
85x100	742127	1000	74.73	10	50	744127	1000	65.19	10	50										

74



																				
	COD.	 4 km/h	Euro																	
80x65	743201	650	54.71	10	50															
80x85	743202	850	60.36	10	50															
85x65	743203	750	57.66	10	50															
85x75 F. 20	743204	750	65.76	10	50															
85x75 F. 25	743224	750	69.36	10	50															
85x85	743205	850	68.12	10	50															
85x95	743206	950	75.98	10	50															

I RULLI TRANSPALLET IN POLIURETANO TR,
NUCLEO IN ACCIAIO

D TR POLYURETHAN-GABELHUBWAGEN-ROLLEN,
STAHLKERN

GB TR POLYURETHANE TRANSPALLET ROLLERS,
STEEL CENTRE

E RODILLOS TRANSPALETAS DE POLIURETANO TR,
NUCLEO DE ACERO

F GALETS TRANSPALETES EN POLYURETHANE TR,
CORPS EN ACIER

RU РОЛИКИ ГИДРАВЛИЧЕСКИХ ТЕЛЕЖЕК ИЗ
ПОЛИУРЕТАНА TR, ОСНОВАНИЕ ИЗ СТАЛИ

75

75



	COD.	4 km/h	Euro			COD.	4 km/h	Euro		
35x27	752099	100	16.47	24	100					
50x40	752100	150	23.76	24	100	754100	150	14.79	24	100
80x40	752101	350	24.95	10	50	754101	350	15.74	10	50
80x70	752102	560	28.12	10	50	754102	560	18.91	10	50
80x90	752105	700	31.10	10	50	754105	700	21.89	10	50
82x60	752131	480	27.61	10	50	754131	480	18.40	10	50
82x70 S. 47x14	752132	560	29.14	10	50	754132	560	19.92	10	50
82x70 S. 47x16	752232	560	28.98	10	50	754232	560	19.77	10	50
82x75	752143	590	29.66	10	50	754143	590	20.45	10	50
82x85	752134	670	31.48	10	50	754134	670	22.27	10	50
82x90	752135	700	32.25	10	50	754135	700	23.04	10	50
82x100	752137	800	35.15	10	50	754137	800	25.94	10	50
85x40	752121	350	25.91	10	50	754121	350	16.69	10	50
85x70	752122	560	30.22	10	50	754122	560	21.01	10	50
85x75	752129	590	32.93	10	50	754129	590	23.72	10	50
85x80 F. 20	752123	630	33.37	10	50	754123	630	24.16	10	50
85x80 F. 25	752223	630	32.72	10	50	754223	630	20.37	10	50
85x85	752136	670	34.14	10	50	754124	670	24.93	10	50
85x90	752125	700	35.23	10	50	754125	700	26.02	10	50
85x100	752127	800	37.26	10	50	754127	800	28.05	10	50

75



	COD.	4 km/h	Euro		
80x65	753101	530	29.33	10	50
80x85	753102	670	32.31	10	50
82x65	753103	530	30.35	10	50
82x80	753104	630	32.70	10	50
82x85	753105	670	33.46	10	50
85x95	753106	750	36.36	10	50
85x65	753107	530	31.43	10	50
85x75 F. 20	753108	590	34.58	10	50
85x75 F. 25	753223	590	33.93	10	50
85x85	753109	670	36.44	10	50
85x95	753110	750	38.47	10	50

I RULLI TRANSPALLET IN POLIURETANO TR,
NUCLEO IN ACCIAIO

D TR POLYURETHAN-GABELHUBWAGEN-ROLLEN,
STAHLKERN

































GB TR POLYURETHANE TRANSPALLET ROLLERS,
STEEL CENTRE































E RODILLOS TRANSPALETAS DE POLIURETANO TR,
NUCLEO DE ACERO

F GALETS TRANSPALETTES EN POLYURETHANE TR,
CORPS EN ACIER

RU РОЛИКИ ГИДРАВЛИЧЕСКИХ ТЕЛЕЖЕК ИЗ
ПОЛИУРЕТАНА TR, ОСНОВАНИЕ ИЗ СТАЛИ

75

75																													
																													
	COD.	3 km/h	Euro	12	100	COD.	3 km/h	Euro	12	100	COD.	3 km/h	Euro	12	50	COD.	3 km/h	Euro	12	100	COD.	3 km/h	Euro	12	100				
35x27	757300	100	23.68	12	100	757400	100	28.12	12	100	757500	100	23.68	12	50	757600	100	28.12	12	100	757600	100	28.12	12	100				
50x40	757301	150	38.49	12	100	757401	150	42.93	12	100	757501	150	38.49	12	50	757601	150	42.93	12	100	757601	150	42.93	12	100				

75																													
																													
	COD.	4 km/h	Euro	4	50	COD.	4 km/h	Euro	4	50																			
80x70	758301	560	110.58	4	50	758401	560	67.83	4	50																			
85x70	758311	560	112.68	4	50	758411	560	69.93	4	50																			
85x80	758321	630	114.79	4	50	758421	630	72.43	4	50																			

I RULLI IN POLIURETANO TR, NUCLEO IN ACCIAIO,
PER TRANSPALLET ELETTRICI

D TR POLYURETHAN-ROLLEN, STAHLKERN,
FÜR ELEKTRISCHE GABELHUGWAGEN

GB TR POLYURETHANE ROLLERS, STEEL CENTRE,
FOR ELECTRICAL PALLET TRUCKS

E RODILLOS DE POLIURETANO TR, NUCLEO DE ACERO,
PARA TRANSPALETAS ELÉCTRICAS









F GALETS EN POLYURETHANE TR, CORPS EN ACIER,
POUR TRANSPALETES ÉLECTRIQUES

RU РОЛИКИ ГИДРАВЛИЧЕСКИХ ТЕЛЕЖЕК ИЗ
ПОЛИУРЕТАНА TR, ОСНОВАНИЕ ИЗ СТАЛИ

75HS

75HS



															
	COD.	 4 km/h	Euro			COD.	 4 km/h	Euro							
85x60 F.12	753151F12	480	31.05	10	50	755151	480	21.22	10	50					
85x60 F.17	753151F17	480	31.05	10	50	755151	480	21.22	10	50					
85x60 F.20	753151F20	480	31.05	10	50	755151	480	21.22	10	50					
85x60 F.25	753151F25	480	31.05	10	50	755151	480	21.22	10	50					
85x65 F.12	753152F12	530	31.57	10	50	755152	530	21.74	10	50					
85x65 F.17	753152F17	530	31.57	10	50	755152	530	21.74	10	50					
85x65 F.20	753152F20	530	31.57	10	50	755152	530	21.74	10	50					
85x65 F.25	753152F25	530	31.57	10	50	755152	530	21.74	10	50					
85x70 F.12	753153F12	560	32.09	10	50	755153	560	22.25	10	50					
85x70 F.17	753153F17	560	32.09	10	50	755153	560	22.25	10	50					
85x70 F.20	753153F20	560	32.09	10	50	755153	560	22.25	10	50					
85x70 F.25	753153F25	560	32.09	10	50	755153	560	22.25	10	50					
85x75 F.12	753154F12	590	32.60	10	50	755154	590	22.77	10	50					
85x75 F.17	753154F17	590	32.60	10	50	755154	590	22.77	10	50					
85x75 F.20	753154F20	590	32.60	10	50	755154	590	22.77	10	50					
85x75 F.25	753154F25	590	32.60	10	50	755154	590	22.77	10	50					
85x80 F.12	753155F12	630	33.12	10	50	755155	630	23.29	10	50					
85x80 F.17	753155F17	630	33.12	10	50	755155	630	23.29	10	50					
85x80 F.20	753155F20	630	33.12	10	50	755155	630	23.29	10	50					
85x80 F.25	753155F25	630	33.12	10	50	755155	630	23.29	10	50					
85x85 F.12	753156F12	670	33.64	10	50	755156	670	23.81	10	50					
85x85 F.17	753156F17	670	33.64	10	50	755156	670	23.81	10	50					
85x85 F.20	753156F20	670	33.64	10	50	755156	670	23.81	10	50					
85x85 F.25	753156F25	670	33.64	10	50	755156	670	23.81	10	50					

I RULLI IN POLIURETANO TR, NUCLEO IN ACCIAIO,
PER TRANSPALLET ELETTRICI

D TR POLYURETHAN-ROLLEN, STAHLKERN,
FÜR ELEKTRISCHE GABELHUGWAGEN

GB TR POLYURETHANE ROLLERS, STEEL CENTRE,
FOR ELECTRICAL PALLET TRUCKS

E RODILLOS DE POLIURETANO TR, NUCLEO DE ACERO,
PARA TRANSPALETAS ELÉCTRICAS

F GALETS EN POLYURETHANE TR, CORPS EN ACIER,
POUR TRANSPALETES ÉLECTRIQUES

RU РОЛИКИ ГИДРАВЛИЧЕСКИХ ТЕЛЕЖЕК ИЗ
ПОЛИУРЕТАНА TR, ОСНОВАНИЕ ИЗ СТАЛИ

75_{HS}

75_{HS}



	COD.	4 km/h	Euro			COD.	4 km/h	Euro								
85x90 F.12	753157F12	700	34.16	10	50	755157	700	24.32	10	50						
85x90 F.17	753157F17	700	34.16	10	50	755157	700	24.32	10	50						
85x90 F.20	753157F20	700	34.16	10	50	755157	700	24.32	10	50						
85x90 F.25	753157F25	700	34.16	10	50	755157	700	24.32	10	50						
85x95 F.12	753158F12	750	34.67	10	50	755158	750	24.84	10	50						
85x95 F.17	753158F17	750	34.67	10	50	755158	750	24.84	10	50						
85x95 F.20	753158F20	750	34.67	10	50	755158	750	24.84	10	50						
85x95 F.25	753158F25	750	34.67	10	50	755158	750	24.84	10	50						
85x100 F.12	753159F12	800	35.19	10	50	755159	800	25.36	10	50						
85x100 F.17	753159F17	800	35.19	10	50	755159	800	25.36	10	50						
85x100 F.20	753159F20	800	35.19	10	50	755159	800	25.36	10	50						
85x100 F.25	753159F25	800	35.19	10	50	755159	800	25.36	10	50						
85x105 F.12	753160F12	840	35.71	10	50	755160	840	25.88	10	50						
85x105 F.17	753160F17	840	35.71	10	50	755160	840	25.88	10	50						
85x105 F.20	753160F20	840	35.71	10	50	755160	840	25.88	10	50						
85x105 F.25	753160F25	840	35.71	10	50	755160	840	25.88	10	50						
85x110 F.12	753161F12	890	36.23	10	50	755161	890	26.39	10	50						
85x110 F.17	753161F17	890	36.23	10	50	755161	890	26.39	10	50						
85x110 F.20	753161F20	890	36.23	10	50	755161	890	26.39	10	50						
85x110 F.25	753161F25	890	36.23	10	50	755161	890	26.39	10	50						

I RULLI TRANSPALLET MONOLITICI
IN POLIAMMIDE 6

D GABELHUBWAGEN-ROLLEN
AUS POLYAMID 6

GB POLYAMIDE 6 TRANSPALLET
ROLLERS

E RODILLOS TRANSPALETAS
DE POLIAMIDA 6









F GALETS TRANSPALETES
EN POLYAMIDE 6

RU ЛИТЫЕ РОЛИКИ ГИДРАВЛИЧЕСКИХ ТЕЛЕЖЕК ИЗ
ПОЛИАМИДА 6

76



76



																				
	COD.	 4 km/h	Euro			COD.	 4 km/h	Euro												
82x60	763011	700	20.17	10	50	761011	700	10.96	10	50										
82x70	763012	850	20.42	10	50	761012	850	11.21	10	50										
82x90	763014	1100	21.47	10	50	761014	1100	12.25	10	50										
82x100	763015	1200	22.84	10	50	761015	1200	13.63	10	50										

76



																				
	COD.		Euro			COD.		Euro												
40x43						760001		2.90	20	50										
50x55	760002		4.24	20	50															

I RULLI TRANSPALLET IN POLIURETANO TR,
NUCLEO IN POLIAMMIDE 6

D TR POLYURETHAN-GABELHUBWAGEN-ROLLEN,
KERN AUS POLYAMID 6

GB TR-POLYURETHANE TRANSPALLET ROLLERS,
POLYAMIDE 6 CENTRE

E RODILLOS TRANSPALETAS DE POLIURETANO TR,
NUCLEO DE POLIAMIDA 6

F GALETS TRANSPALETES EN POLYURTEHANE TR,
CORPS EN POLYAMIDE 6

RU РОЛИКИ ГИДРАВЛИЧЕСКИХ ТЕЛЕЖЕК ИЗ
ПОЛИУРЕТАНА TR,
ОСНОВАНИЕ ИЗ ПОЛИАМИДА 6

77

77



	COD.	4 km/h	Euro			COD.	4 km/h	Euro												
82x70	772132	450	23.70	10	50	774132	450	15.53	10	50										
82x90	772135	510	25.77	10	50	774135	510	17.60	10	50										
82x100	772137	600	26.50	10	50	774137	600	18.32	10	50										
85x70	772122	500	24.53	10	50	774122	500	16.35	10	50										
85x90	772125	600	26.50	10	50	774125	600	18.32	10	50										

I RULLI TRANSPALLET IN POLIURETANO
TERMOPLASTICO, NUCLEO IN POLIAMMIDE 6

D THERMOPLASTISCUE POLYURETHAN
-GABELHUBWAGEN- ROLLEN, KERN AUS POLYAMID 6

GB THERMOPLASTIC POLYURETHANE TRANSPALLET
ROLLERS, POLYAMIDE 6 CENTRE

E RODILLOS TRANSPALETAS DE POLIURETANO
TERMOPLASTICO, NUCLEO DE POLIAMIDA 6

F GALETS TRANSPALETES EN POLYURETHANE
THERMOPLASTIQUE, CORPS EN POLYAMIDE 6

RU РОЛИКИ ГИДРАВЛИЧЕСКИХ ТЕЛЕЖЕК ИЗ
ИНЖЕКТОРНОГО ПОЛИУРЕТАНА,
ОСНОВАНИЕ ИЗ ПОЛИАМИДА 6

78

78



	COD.	4 km/h	Euro	■	■	COD.	4 km/h	Euro	■	■										
82x60	782101	450	17.84	10	50	784101	450	9.67	10	50										
82x70	782102	500	18.42	10	50	784102	500	10.25	10	50										
82x80	782103	600	19.56	10	50	784103	600	11.39	10	50										
82x90	782104	700	20.29	10	50	784104	700	12.11	10	50										
82x100	782105	750	22.05	10	50	784105	750	13.87	10	50										

I RULLI TRANSPALLET IN POLIURETANO TR-ROLL,
NUCLEO IN ACCIAIO

D TR-ROLL POLYURETHAN-GABELHUBWAGEN-ROLLEN,
STAHLKERN

GB TR-ROLL POLYURETHANE TRANSPALLET ROLLERS,
STEEL CENTRE

E RODILLOS TRANSPALETAS DE POLIURETANO
TR-ROLL, NUCLEO DE ACERO

F GALETS TRANSPALETES EN POLYURETHANE
TR-ROLL, CORPS EN ACIER

RU РОЛИКИ TRANSPALLET ИЗ ПОЛИУРЕТАНА
TR-ROLLOCHOВAНИЕ ИЗ СТАЛИ

79

79



	COD.	4 km/h	Euro	■	■	COD.	4 km/h	Euro	■	■										
80x90	792105	580	38.81	10	50	794105	580	30.64	10	50										
82x60	792121	400	33.43	10	50	794121	400	25.25	10	50										
82x70	792122	450	35.40	10	50	794122	450	27.22	10	50										
82x90	792125	580	39.33	10	50	794125	580	31.15	10	50										
82x100	792127	650	40.16	10	50	794127	650	31.98	10	50										
85x70	792132	450	35.81	10	50	794132	450	27.63	10	50										
85x80	792133	520	37.98	10	50	794133	520	29.81	10	50										
85x90	792135	580	40.37	10	50	794135	580	32.19	10	50										
85x100	792137	650	42.64	10	50	794137	650	34.47	10	50										

I RUOTE PNEUMATICHE,
NUCLEO IN POLIPROPILENE



















D LUFTBEREIFTE RÄDER,
POLYPROPYLENKERN

GB PNEUMATIC WHEELS,
POLYPROPYLENE CENTRE



















E RUEDAS NEUMATICAS,
NUCLEO DE POLIPROPILENO

F ROUES PNEUMATIQUES,
CORPS EN POLYPROPYLENE

RU ПНЕВМАТИЧЕСКИЕ КОЛЕСА,
ОСНОВАНИЕ ИЗ ПОЛИПРОПИЛЕНА

82		RIB PROFILE						RIB PROFILE						RIB PROFILE										
							 					 												
	COD.		Euro				COD.		Euro				COD.		Euro									
260x85 F. 20	821601	150	25.11	4	12																			
260x85 F. 25	821602	150	25.11	4	12	825601	150	74.52	1	8			826601	150	51.19	1	8							

82		COUNTRY PROFILE						COUNTRY PROFILE						COUNTRY PROFILE										
							 					 												
	COD.		Euro				COD.		Euro				COD.		Euro									
260x85 F. 20	822601	150	25.78	4	12																			
260x85 F. 25	822602	150	25.78	4	12	825602	150	75.19	1	8			826602	150	51.86	1	8							

82		RIB PROFILE						RIB PROFILE						RIB PROFILE										
							 					 												
	COD.		Euro				COD.		Euro				COD.		Euro									
260x85 F. 20	823601	150	27.23	4	12																			
260x85 F. 25	823602	150	27.23	4	12	825701	150	76.64	1	8			826701	150	53.31	1	8							

82		COUNTRY PROFILE						COUNTRY PROFILE						COUNTRY PROFILE										
							 					 												
	COD.		Euro				COD.		Euro				COD.		Euro									
260x85 F. 20	824601	150	27.90	4	12																			
260x85 F. 25	824602	150	27.90	4	12	825702	150	77.31	1	8			826702	150	53.99	1	8							

I RUOTE PNEUMATICHE ANTIFORATURA,
NUCLEO IN POLIPROPILENE

D PANNENFREIE RÄDER,
KERN AUS POLYPROPYLEN

GB PUNCTURE-PROOF PNEUMATIC WHEELS,
POLYPROPYLENE CENTRE

E RUEDA NEUMATICA IMPINCHABLE,
NUCLEO DE POLIPROPILENO







F ROUES PNEUMATIQUES ANTI-CREVAISON,
CORPS EN POLYPROPYLENE

RU ПНЕВМАТИЧЕСКИЕ КОЛЕСА,
ОСНОВАНИЕ ИЗ ПОЛИПРОПИЛЕНА

82_{AF}

82_{AF}



						  NL					  NL									
	COD.	Static	Euro	■	■	COD.	Static	Euro	■	■	COD.	Static	Euro	■	■					
260x75	823701	70	29.18	4	12	827601	70	78.59	1	8	828601	70	55.26	1	8					

I CONTROPIASTRE, CODOLI,
RONDELLE, DADI



D GEGENPLATTEN, ZAPFEN,
SCHEIBE, MUTTER





GB COUNTERPLATES, STEMS,
BOLT, NUTS





E CONTRAPLACAS, ESPIGA,
ARANDELA, TUERCA

F CONTRE-PLATINES, TIGES,
RONDELLES, ECROUS

RU ПАНЕЛИ И ХВОСТОВИКИ КРОНШТЕЙНОВ,
ШАЙБЫ, ГАЙКИ

												
	COD.	Euro			COD.	Euro						
80	926044	2.64			921079	0.36						
100	926044	2.64			921079	0.36						
125	926044	2.64			921079	0.36						
140/150	926044	2.64			921079	0.36						
150/160	926006	6.39			921070	1.72						
175/180	926006	6.39			921070	1.72						
200	926006	6.39			921070	1.72						

																
	COD.	Euro			COD.	Euro			COD.	Euro			COD.	Euro		
80	925005	0.30							922028	0.28						
100	925005	0.30							922028	0.28						
125	925006	0.30							922112	0.28						
140/150	925006	0.30							922112	0.28						
150/160	925007	1.51			929324	0.19			922108	0.42			947015	0.30		
175/180	925007	1.51			929324	0.19			922108	0.42			947015	0.30		
200	925007	1.51			929324	0.19			922108	0.42			947015	0.30		

	 NL				 NLX				 P				 EP			
	COD.	Euro			COD.	Euro			COD.	Euro			COD.	Euro		
80	110401	1.59			110402	6.42										
100	110401	1.59			110402	6.42			110403	1.88			110202	2.75		
125	110401	1.59			110402	6.42			110403	1.88			110202	2.75		
140/150	110401	1.59			110402	6.42			110403	1.88			110204	2.75		
150/160	110105	3.35			110106	7.12			110204	11.11			110204	11.11		
175/180	110105	3.35			110106	7.12			110204	11.11			110204	11.11		
200	110105	3.35			110106	7.12			110204	11.11			110204	11.11		
250													110208	15.66		

I BLOCCAGGI DIREZIONALI

D RICHTUNGSFESTSTELLER

GB DIRECTIONAL LOCKS

E POSICIONADOR DIRECCIONAL

F BLOCAGES DIRECTIONNELS

RU ФИКСАТОР НАПРАВЛЕНИЯ ДВИЖЕНИЯ



	NL-P																		
	COD.	4 km/h	Euro																
160-200	401215	300	10.84																



	EE MHD EEG MHD			2x180° slots Castor price list increase			4x90° slots Castor price list increase												
	COD.	4 km/h	Euro	COD.	4 km/h	Euro	COD.	4 km/h	Euro										
100-250	401216	1000	34.93	-B2	1000	2.26	-B4	1000	7.92										



	EE HD			2x180° slots Castor price list increase			4x90° slots Castor price list increase												
	COD.	4 km/h	Euro	COD.	4 km/h	Euro	COD.	4 km/h	Euro										
100-250	401217	1000	45.21	-D2	1000	9.05	-D4	1000	15.83										

I PARAPIEDI

D FUßSCHUTZ

GB FOOTGUARDS

E GUARDAPIE'

F PARE-PIED

RU ЗАЩИТЫ ДЛЯ НОГ



	NL		NL-M		M														
	COD.	Euro																	
125 P. 100x85	094635VE	13.97			094630VE	13.97													
125 P. 140x110	094744VE	22.91			094688VE	22.91													
150	094781VE	22.91			094761VE	22.91			094641VE	22.91									
160	094781VE	22.91			094761VE	22.91			094641VE	22.91									
200	094782VE	22.91			094762VE	22.91			094783VE	22.91									



	P-PT		P-PT																
	COD.	Euro																	
125 P. 100x85	094689VE	13.97			094630VE	13.97													
150	094641VE	22.91			094641VE	22.91													
160	094641VE	22.91			094641VE	22.91													
175-180	094784VE	22.91			094784VE	22.91													
200	094784VE	22.91			094784VE	22.91													



Questo listino presenta la gamma completa dei prodotti standard Tellure Rôta.

Per soluzioni non presenti in questo listino, Vi preghiamo di contattare direttamente il nostro Servizio Commerciale.

Valuteremo con attenzione ogni Vostra richiesta e Vi forniremo un'offerta personalizzata.

Le présent tarif contient la gamme complète des produits standard Tellure Rôta.

Pour toute solution non présentée dans ce tarif, nous vous prions de bien vouloir prendre contact avec notre Service Commercial. Nous étudierons avec soin toute demande et vous soumettrons une offre personnalisée.

Esta tarifa presenta la gama completa de los productos estándar Tellure Rôta.

Para soluciones no presentes en esta tarifa, les rogamos que contacten directamente con nuestro Departamento Comercial.

Evaluaremos detenidamente sus solicitudes y les presentaremos una oferta personalizada.

This price list contains the complete line of standard Tellure Rôta products.

For versions not included in this price list, please contact our Sales Department.

We will carefully analyse your request and provide you with a personalised offer.

Diese Preisliste enthält das komplette Sortiment der Standardprodukte von Tellure Rôta.

Bitte wenden Sie sich im Falle nicht in dieser Preisliste enthaltener Lösungen direkt an unsere Handelsabteilung.

Wir werden jeden Bedarf aufmerksam prüfen und Ihnen ein individuell gestaltetes Angebot unterbreiten.

Этот ценовой лист представляет полную гамму стандартных изделий фирмы Tellure Rôta. Для решений, непредусмотренных в этом ценовом листе, мы просим Вас напрямую связываться с нашим Коммерческим Отделом. Мы внимательно рассмотрим любое Ваше требование и предоставим коммерческое предложение, сделанное специально для Вас.

1. Generalità

Il rapporto contrattuale conseguente il perfezionamento di ogni singolo ordine è disciplinato dalle presenti condizioni di vendita e dalle eventuali condizioni specifiche eventualmente espresse nell'ordine stesso, ove specificatamente sottoscritte. Gli ordini passati ad ausiliari ed intermediari del commercio vengono assunti salvo approvazione della Tellure Rôta S.p.A.

2. Offerta

I documenti che fanno parte dell'offerta, come illustrazioni, disegni, indicazioni di peso e dimensioni, sono determinanti soltanto in via approssimativa, nella misura in cui essi non sono stati espressamente indicati come vincolanti. La Tellure Rôta S.p.A. si riserva il diritto di proprietà e il diritto d'autore relativi a preventivi di spese, disegni e altri documenti, i quali non devono essere resi accessibili a terzi. Il committente si assume la piena responsabilità per i documenti che lo stesso ha consegnato a Tellure Rôta S.p.A., in caso di violazione dei diritti di protezione industriale di terzi, anche nel rapporto con Tellure Rôta S.p.A. Quest'ultima è tenuta a rendere accessibili a terzi i progetti indicati dal committente come confidenziali solamente con l'approvazione del medesimo.

3. Ordini

Non sono previsti ordini di valore inferiore a 500,00 Euro salvo diversa pattuizione scritta.

4. Variazione dell'ordine confermato

La Tellure Rôta S.p.A. si riserva la facoltà di rifiutare o accettare, anche solo parzialmente, eventuali variazioni successive d'ordine e proposte del compratore. Nell'ipotesi di accettazione di tali variazioni, il nuovo prezzo, le modalità di pagamento o le nuove date di riconsegna verranno fissate dalla Tellure Rôta S.p.A. rimanendo invariate tutte le altre condizioni.

5. Annullamento dell'ordine confermato

Il committente che annulla un ordine confermato, per qualsiasi motivo o ragione, è tenuto a pagare integralmente l'importo relativo ai materiali e alle forniture già ordinate dalla Tellure Rôta S.p.A. La Tellure Rôta S.p.A. ha in ogni caso diritto ad un indennizzo minimo pari al 25% del prezzo pattuito con la facoltà di trattenere questo importo anche dall'eventuale somma ricevuta a titolo di pagamento anticipato della fornitura.

6. Prezzi

I prezzi si intendono per materiale reso franco fabbrica Tellure Rôta S.p.A., salvo diversa pattuizione scritta. I prezzi del prodotto sono quelli esposti dalla Tellure Rôta S.p.A. nei suoi listini in vigore o nelle sue offerte; tali prezzi, se non ancora concordati, potranno però essere variati in qualsiasi momento e saranno applicati inderogabilmente alla data fissata dalla Tellure Rôta S.p.A.

7. Pagamenti

Il pagamento delle forniture deve essere effettuato entro il termine ed alle condizioni convenute nell'ordine. La Tellure Rôta S.p.A. è autorizzata in ogni caso ad emettere tratte sul cliente per le somme ed alle scadenze dovute. Le relative spese sono a carico del cliente. Ogni spedizione è considerata indipendente dalle altre agli effetti del pagamento. Il ritardo dei pagamenti o qualsiasi altra inadempienza danno diritto alla sospensione delle restanti forniture e alla risoluzione dei contratti in corso, oltre a dar luogo alla messa in mora del compratore con immediata decorrenza degli interessi di mora. Sulle somme scadute e non pagate, fermo il diritto della Tellure Rôta S.p.A. di esigere il pagamento, decorreranno, di pieno diritto, dal giorno successivo alla scadenza dovuta, gli interessi di mora aumentati di otto punti rispetto al tasso fissato dalla B.C.E. in rispetto al D. Lgs 192/2012. Non sono ammesse richieste di rimborso, pagamenti o compensazioni in virtù di qualsiasi eventuale contropretesa da parte del committente.

8. Termini di consegna

I termini di spedizione e/o di consegna concordati o confermati, sono espressi in giorni lavorativi ed hanno solo valore indicativo e come tale giuridicamente non vincolante, eccettuato il caso di impegno tassativo di Tellure Rôta S.p.A., che dovrà risultare espressamente nella conferma d'ordine, e salvo i casi di forza maggiore. Eventuali ritardi non potranno quindi, in nessun caso, dar luogo a risarcimenti danno o alla risoluzione, anche parziale, del contratto, eccetto che tali conseguenze non siano espressamente accettate da Tellure Rôta S.p.A. nella conferma d'ordine.

9. Spedizione e trasporto

Salva pattuizione contraria, che deve risultare dalla conferma d'ordine, la vendita avviene franco fabbrica (Ex-works). Sono ammissibili delle spedizioni parziali da parte della Tellure Rôta S.p.A. Anche nell'ipotesi in cui la Tellure Rôta S.p.A. dovesse pagare il prezzo relativo al trasporto della merce fino al luogo di destinazione convenuto, il rischio di perdita o di danni alla merce, come pure ogni spesa addizionale dovuta per fatti accaduti solo dopo che la merce sia stata consegnata al vettore, si trasferisce dalla Tellure Rôta S.p.A. al compratore nel momento in cui la merce è stata consegnata al vettore. Eventuali riserve, danni, azioni derivanti e comunque connesse con il trasporto ed operazioni successive, dovranno essere proposti dal compratore, ed esclusivamente nei confronti del vettore, entro il termine improrogabile di otto giorni dal ricevimento della merce, non essendo Tellure Rôta S.p.A. responsabile per quanto avvenuto dopo la consegna dei materiali al vettore medesimo. La Tellure Rôta S.p.A. provvederà all'imballaggio secondo esperienza ed usi restando esplicitamente esonerata da ogni responsabilità per perdita e/o avarie.

L'impiego di imballaggi particolari, ovvero l'esclusione dell'imballaggio nel caso di merce per il quale esso è normalmente usato, dovrà essere convenuto fra Tellure Rôta S.p.A. e compratore all'atto dell'ordinazione. Per quanto non previsto e se ed in quanto compatibili con il presente punto, si intendono qui richiamati gli articoli dal 1678 al 1702 del C.C. I campioni vengono messi a disposizione da parte di Tellure Rôta S.p.A. soltanto alla condizione di addebito supplementare di volta in volta dei relativi prezzi in vigore.

10. Vizi e difetti

Eventuali reclami per materiali non corrispondenti, sia per quantità sia per qualità, a quanto concordato nell'ordine, debbono essere proposti per iscritto entro il termine massimo di otto giorni dal ricevimento della merce a pena di decadenza. Qualora il reclamo risulti tempestivo e risulti fondato, l'obbligo di Tellure Rôta S.p.A. è limitato alla sostituzione della merce riconosciuta non corrispondente (comunque sempre allo stato di fornitura) nello stesso luogo di consegna della fornitura iniziale, previa restituzione di questa, escluso qualsiasi diritto da parte del compratore di richiedere la risoluzione del contratto e il risarcimento di danni diretti o indiretti ed il rimborso delle spese a qualsiasi titolo sostenute. La Tellure Rôta S.p.A. non accetterà reclami e non risponderà di danni arrecati a terzi al verificarsi di una sola delle seguenti condizioni: utilizzo inappropriato o non corretto, montaggio difettoso ad opera di un committente o di un terzo, usura naturale, manipolazione non corretta o negligente, effetti elettrici o chimici, nella misura in cui essi non siano imputabili a colpa della Tellure Rôta S.p.A. Il compratore perde ogni diritto di reclamo, e quindi di sostituzione della merce, ove non sospenda immediatamente l'impiego dei materiali oggetto della contestazione.

11. Resi di materiali

In caso di errore del compratore in fase di ordinazione, il materiale potrà essere restituito esclusivamente in porto franco, dietro autorizzazione scritta dalla Tellure Rôta S.p.A., solo se perfettamente integro e non utilizzato.

12. Modificazioni nella costruzione

La Tellure Rôta S.p.A. può apportare qualsiasi modificazione nelle sue costruzioni senza obbligo di notificarla al compratore. Le modifiche apportate successivamente all'ordinazione non possono dar luogo a risarcimento di sorta.

1. General terms

The contractual relationship, further to the conclusion of each single order, is regulated by these general terms of sale and by specific terms which may be indicated in the order, where specifically undersigned. Orders passed on to commercial assistants and intermediaries are accepted subject to the approval of Tellure Rôta S.p.A.

2. Offer

The documents forming part of the offer, such as illustrations, drawings, indications of weight and size, are only determinant in approximate terms to the extent that they have not been expressly indicated as binding. Tellure Rôta S.p.A. reserves the right of ownership and copyright with regards to the cost estimates, drawings and other documents, which must not be made accessible to third parties. The purchaser assumes full responsibility for the documents it has sent to Tellure Rôta S.p.A. in the event of breach of third party industrial protection rights, also in relation with Tellure Rôta S.p.A. The latter is obliged to make projects, indicated by the purchaser as confidential, accessible to third parties only upon the purchaser's approval.

3. Orders

Except in the event of different written terms, orders of less than Euro 500.00 are not accepted.

4. Variation in the confirmed order

Tellure Rôta reserves the right to refuse or accept, also only partially, any subsequent changes in the order and proposals by the purchaser. In the event of acceptance of these variations, the new price, methods of payment and new delivery dates shall be established by Tellure Rôta, with all other terms remaining unchanged.

5. Cancellation of a confirmed order

The purchaser that cancels a confirmed order, for any cause or motive, is bound to pay in full the amount relating to materials and to supplies already ordered by Tellure Rôta S.p.A. In any case, Tellure Rôta S.p.A. has the right to a minimum compensation equal to 25% of the agreed price, with the right to withdraw this amount even from possible sums received as advance payment for the supply.

6. Prices

Prices are considered as applying to material delivered ex works from Tellure Rôta S.p.A., except in the event of different written terms. The prices of products are those shown by Tellure Rôta S.p.A. in its price list or in its offers; these prices, if not yet agreed, may however be changed at any moment and will be absolutely applied at the date fixed by Tellure Rôta S.p.A.

7. Payments

Payment of supplies must be made within the period and the terms agreed to in the order. In all events, Tellure Rôta S.p.A. is authorised to issue drafts on the customer for the sums and at the due dates. The relative costs are to be borne by the customer. Every shipment is considered as independent of others for the purpose of payment. Delays in payments or any other breach give right to the suspension of the remaining supplies and to the rescission of the contract in progress, besides giving rise to default action against the purchaser with the immediate application of interests on arrears. On sums falling due and not paid, without prejudice to Tellure Rôta S.p.A.'s right to demand payment, interests on arrears will apply, with full right, from the day after the due date, at the legal rate of interest on arrears plus eight points, in compliance with the rate set by the ECB in respect of Italian Legislative Decree no. 192/2012. Requests for reimbursement of payments or for compensations by virtue of any possible counter-claim on the part of the purchaser are not accepted.

8. Delivery terms

The agreed and confirmed shipment and/or delivery terms are expressed in working days and are only indicative and as such are not legally binding, except in the event of a definite undertaking on the part of Tellure Rôta S.p.A., which must be expressly indicated on the order confirmation, and except in cases of force majeure. Any delays may not therefore, in any event, give rise to compensation for damages or the rescission, even partial, of the contract, except where such consequences are expressly accepted by Tellure Rôta S.p.A. in the order confirmation.

9. Shipment and transport

With the exception of a contrary agreement, which must be indicated in the order confirmation, the sale takes place Ex-Works. Partial shipments by Tellure Rôta S.p.A. are also accepted. Also in the event that Tellure Rôta S.p.A. is obliged to pay the relative transport cost for the goods as far as the agreed destination, the risk of loss or damage to the goods, as well as any additional costs due to events occurring after the goods have been consigned to the carrier, is transferred from Tellure Rôta S.p.A. to the purchaser at the moment in which the goods are consigned to the carrier. Any reserves, claims, or actions deriving from or in any case connected with the transport and consequent operations, must be raised by the purchaser, and exclusively against the carrier, with the absolute term of eight days from receipt of the goods, since Tellure Rôta S.p.A. is not responsible for events occurring after the consignment of the material to the carrier. Tellure Rôta S.p.A. will take care of the packaging according to experience and common practice, remaining explicitly exonerated from any responsibility for loss and/or damage.

The use of special packaging, including the exclusion of packaging in the case of goods for which this is normal practice must be agreed to between Tellure Rôta S.p.A. and the purchaser upon making the order. With regards to matters not provided for, reference should be made to articles 1678 and 1702 of the Civil Code if, and to the extent, they are compatible with this clause. Samples are made available by Tellure Rôta S.p.A.'s only upon the application of a supplementary charge to be agreed from time to time on the relative price in force.

10. Faults and defects

Any claims for materials not corresponding, both in terms of quantity and of quality, to the conditions agreed to in the order, must be raised in writing within the maximum term of eight days from receipt of the goods on penalty of forfeiture. In the event of a prompt and justified claim, Tellure Rôta S.p.A.'s obligation is limited to the replacement of the goods acknowledged as not corresponding (in any case at supply conditions), to the same delivery destination as the initial supply, subject to the restitution of this initial supply, excluding any right on the part of the purchaser to request the rescission of the contract and compensation for direct or indirect damages and the reimbursement of any costs sustained for any reason. Tellure Rôta S.p.A. will not accept claims and will not be liable for damages suffered by third parties upon the occurrence of any of the following conditions: inappropriate or incorrect use, defective assembly on the part of the purchaser or of a third party, natural wear and tear, incorrect or negligent handling, electric or chemical effects, to the extent that these are not attributable to the fault of Tellure Rôta S.p.A. The purchaser loses every right of claim, and therefore the replacement of the goods, in the event that it fails to immediately suspend the use of the materials to which the claim refers.

11. Returns of materials

In the event of errors by the purchaser during the ordering phase, the material may be returned exclusively carriage free, against Tellure Rôta S.p.A.'s written authorisation, and only if perfectly integral and unused.

12. Changes in the construction

Tellure Rôta S.p.A. may make any changes in its construction without the obligation to inform the purchaser. Changes made subsequent to the order cannot give rise to compensation of any kind.

1. Généralités

Le rapport contractuel suivant la réalisation de chaque commande est réglementé par les présentes conditions de vente et d'éventuelles conditions spécifiques, exprimées dans la commande, si spécifiquement sous-critées. Les commandes passées par des auxiliaires et intermédiaires de commerce ne sont admises qu'après approbation de Tellure Rôta S.p.A.

2. Offre

Les documents qui font partie de l'offre, tels que les illustrations, les plans techniques, les indications de poids et les dimensions, ne sont qu'indicatifs, dans la mesure où ils n'ont pas été expressément indiqués comme contraignants. Tellure Rôta S.p.A. se réserve le droit de propriété et le droit d'auteur relatifs à des devis, plans techniques et autres documents, qui ne doivent pas être rendus accessibles à des tiers. Le commettant s'assume la pleine responsabilité pour les documents qu'il a lui-même remis à Tellure Rôta S.p.A., en cas de violation des droits de protection industrielle de tiers, même dans le rapport avec Tellure Rôta S.p.A. Cette dernière n'est tenue de divulguer à des tiers les projets indiqués comme confidentiels par le commettant qu'avec l'approbation de celui-ci.

3. Commandes

Les commandes ayant une valeur inférieure à 500,00 Euros ne sont pas prévues, sauf négociation écrite différente.

4. Modification de la commande confirmée

Tellure Rôta S.p.A. se réserve le droit de refuser ou d'accepter, même seulement partiellement, d'éventuelles modifications successives à la commande et aux propositions de l'acheteur. Dans l'hypothèse d'une acceptation de ces modifications, le nouveau prix, les modalités de paiement ou les nouvelles dates de livraison seront fixés par Tellure Rôta S.p.A. sans changer les autres conditions.

5. Annulation de la commande confirmée

Le commettant qui annule une commande confirmée, pour n'importe quel motif ou raison, est tenu de payer intégralement le montant relatif aux matériaux et aux fournitures déjà commandés par Tellure Rôta S.p.A. Tellure Rôta S.p.A. a, dans tous les cas, droit à une indemnité minimum égale à 25% du prix négocié, et a aussi le droit de retenir ce montant de l'éventuelle somme reçue à titre de paiement anticipé de la fourniture.

6. Prix

Les prix s'entendent pour matériel rendu départ-usine (Ex-works) Tellure Rôta S.p.A., sauf négociation écrite différente. Les prix du produit sont ceux exposés par Tellure Rôta S.p.A. dans ses prix tarifs en vigueur ou dans ses offres; ces prix, s'ils ne sont pas encore concordés, pourront cependant être changés à tout moment et seront appliqués inéluctablement à la date fixée par Tellure Rôta S.p.A.

7. Paiements

Le paiement des fournitures doit être effectué dans les délais et aux conditions convenues dans la commande. Tellure Rôta S.p.A. peut, dans tous les cas, émettre des traites sur le client pour les sommes et aux échéances dues. Les frais correspondants sont à la charge du client. Chaque expédition est considérée indépendante des autres aux effets du paiement. Le retard des paiements ou toute autre défaillance donnent droit à la suspension des fournitures restantes et à la résiliation des contrats en cours, en plus de donner lieu à la mise en demeure de l'acheteur avec prise d'effet immédiate des intérêts liés à la mise en demeure. Sur les sommes échues et non payées, bien qu'étant entendu le droit de Tellure Rôta S.p.A. d'en exiger le paiement, les intérêts liés à la mise en demeure prendront effet de plein droit à partir du jour suivant l'échéance, et seront majorés de huit points par rapport au taux fixé par la B.C.E conformément au D. Lgs 192/2012. Les demandes de remboursement, de paiements ou de compensations ne sont pas admises, en vertu de toute éventuelle contre-prétention, de la part du commettant.

8. Délais de livraison

Les délais d'expédition et/ou de livraison fixés ou confirmés, sont exprimés en jours ouvrables et ont seulement une valeur indicative et, comme telle, juridiquement non contraignantes, sauf cas d'engagement péremptoire de Tellure Rôta S.p.A., qui devra être expressément signifié dans la confirmation de la commande, et sauf cas de force majeure. D'éventuels retards ne pourront donc, en aucun cas, donner lieu à des dommages-intérêts ou à la résiliation, même partielle, du contrat, sauf si ces conséquences sont expressément acceptées par Tellure Rôta S.p.A. dans la confirmation de la commande.

9. Expédition et transport

Sauf disposition contraire, qui doit être spécifiée dans la confirmation de la commande, la vente s'effectue départ-usine (Ex-works.) Des expéditions partielles de la part de Tellure Rôta S.p.A. sont admissibles. Même dans l'hypothèse où Tellure Rôta S.p.A. devait payer le prix relatif au transport de la marchandise jusqu'au lieu de destination convenu, le risque de perte ou de dommages à la marchandise, ainsi que toute dépense supplémentaire due à des faits successifs à la remise de la marchandise au transporteur, est transféré de Tellure Rôta S.p.A. à l'acheteur si la marchandise a été remise au transporteur. D'éventuelles réserves, dommages, actions dérivant et, de toute façon, se rapportant au transport et aux opérations successives, devront être proposés par l'acheteur, et exclusivement vis-à-vis du transporteur, dans les huit jours suivant la réception de la marchandise, étant donné que Tellure Rôta S.p.A. n'est pas responsable de ce qui se produit après la remise des matériaux au transporteur. Tellure Rôta S.p.A. fournira un emballage, selon l'expérience et les usages, mais restera explicitement exonérée de toute responsabilité en cas de perte et/ou d'avaries.

L'emploi d'emballages particuliers, c'est-à-dire l'exclusion de l'emballage en cas de marchandise pour laquelle il est normalement utilisé, devra être convenu entre Tellure Rôta S.p.A. et l'acheteur au moment de la commande. Concernant ce qui n'est pas prévu et si cela est compatible avec le présent point, voir les articles de 1678 à 1702 du C.C. Les échantillons mis à disposition par Tellure Rôta S.p.A. sont sujets à de coûts supplémentaires en fonction des prix en vigueur correspondants.

10. Vices et défauts

D'éventuelles réclamations pour matériaux non conformes à ce qui est établi dans la commande soit par la quantité soit par la qualité, doivent être faites par écrit au maximum dans les huit jours suivant la réception de la marchandise, sous peine de déchéance. Si la réclamation est opportune et fondée, l'obligation de Tellure Rôta S.p.A. est limitée au remplacement de la marchandise non conforme (de toute façon, toujours à l'état de fourniture) dans le même lieu de livraison de la fourniture initiale, avec restitution préalable de celle-ci, excluant tout droit de la part de l'acheteur de demander la résiliation du contrat et des dommages-intérêts, directs ou indirects, et le remboursement des frais soutenus à tout titre. Tellure Rôta S.p.A. n'acceptera pas de réclamations et ne répondra pas de dommages apportés à des tiers pour une quelconque des conditions suivantes: utilisation inappropriée ou incorrecte, montage défectueux par un commettant ou un tiers, usure naturelle, manipulation incorrecte ou négligente, effets électriques ou chimiques dans la mesure où ils ne soient pas imputables à Tellure Rôta S.p.A. L'acheteur perd tout droit de réclamation, et donc de remplacement de la marchandise, s'il ne suspend pas immédiatement l'utilisation du matériel objet de la contestation.

11. Retours de matériels

En cas d'erreur de l'acheteur en phase de commande, le matériel pourra être retourné exclusivement droits acquittés, après autorisation écrite de Tellure Rôta S.p.A., seulement si parfaitement intègre et non utilisé.

12. Modifications dans la construction

Tellure Rôta S.p.A. peut apporter toute modification dans ses constructions sans obligation de la notifier à l'acheteur. Les modifications apportées successivement à la commande ne peuvent donner lieu à aucune sorte de dédommagement.

1. Allgemeine Bestimmungen

Das Vertragsverhältnis, das sich aus dem Zustandekommen jedes einzelnen Auftrages ergibt, unterliegt den vorliegenden allgemeinen Verkaufsbedingungen sowie den Sonderbedingungen, die eventuell im betreffenden Auftrag aufgeführt sind, soweit diese ausdrücklich unterschieden wurden. An Geschäftsgehilfen und -vertreter weitergegebene Aufträge werden unter Voraussetzung der Genehmigung durch Firma Tellure Rôta S.p.A. angenommen.

2. Angebot

Die Unterlagen, die Teil des Angebotes sind, wie Abbildungen, Zeichnungen, Angaben zu Gewicht und Abmessungen, sind nur annähernd maßgebend und zwar in dem Umfang, in dem sie nicht ausdrücklich als verbindlich angegeben wurden. Die Firma Tellure Rôta S.p.A. behält sich das Eigentumsrecht sowie das Urheberrecht für alle Kostenvorschläge, Zeichnungen und weitere Unterlagen vor, welche Dritten nicht zugänglich gemacht werden dürfen. Der Auftraggeber haftet in vollem Umfang für die Unterlagen, die er der Firma Tellure Rôta S.p.A. ausgehändigt hat, im Falle einer Verletzung von gewerblichen Schutzrechten von Dritten, auch im Verhältnis mit der Firma Tellure Rôta S.p.A. Die letztgenannte ist verpflichtet, die vom Auftraggeber angegebene Pläne Dritten in vertraulicher Form ausschließlich mit Genehmigung desselben zugänglich zu machen.

3. Aufträge

Aufträge unter 500,00 Euro sind normalerweise nicht vorgesehen und müssen schriftlich vereinbart werden.

4. Änderungen des bereits bestätigten Auftrages

Die Firma Tellure Rôta S.p.A. behält sich das Recht vor, eventuelle nach einem Auftrag erfolgte Änderungen und Vorschläge seitens des Käufers abzulehnen oder, auch nur teilweise, anzunehmen. In der Annahme, dass eventuelle Änderungen angenommen werden, werden der neue Preis, die Zahlungsbedingungen bzw. die neue Liefertermine von der Firma Tellure Rôta S.p.A. festgesetzt, unter Beibehaltung aller anderen Bedingungen.

5. Stornierung des bereits betätigten Auftrags

Der Auftraggeber, der aus welchem Grund auch immer einen bereits bestätigten Auftrag storniert, ist verpflichtet, den vollständigen Betrag für die bereits bei Firma Tellure Rôta S.p.A. bestellten Materialien und Lieferungen zu entrichten. Die Firma Tellure Rôta S.p.A. hat in jedem Fall Anspruch auf eine Mindest-Schadenersatz in Höhe von 25% vom vereinbarten Preis; sie ist weiterhin berechtigt, diesen Betrag von einer eventuell als Vorauszahlung auf die Lieferung erhaltenen Summe einzubehalten.

6. Preise

Soweit keine abweichende schriftliche Vereinbarungen bestehen, verstehen sich die Preise für Material ab Werk Tellure Rôta S.p.A. Die Preise für die Erzeugnisse entsprechen den in den gültigen Preislisten bzw. in den Angeboten der Firma Tellure Rôta S.p.A. angegebene Preise; soweit diese Preise noch nicht vereinbart sind, können diese jederzeit abgeändert werden und werden zu dem von Firma Tellure Rôta S.p.A. festgesetzten Datum unaufschiebbar angewendet.

7. Zahlung

Die Zahlung der Lieferungen erfolgt innerhalb der im Auftrag vereinbarten Frist und zu den vereinbarten Bedingungen. Die Firma Tellure Rôta S.p.A. ist in jedem Fall ermächtigt, Wechsel auf den Kunden für die zu den fälligen Fristen ausstehenden Beträge zu ziehen. Die daraus entstehenden Kosten gehen zu Lasten des Kunden. Was die Zahlung betrifft, wird jede Lieferung unabhängig von den anderen betrachtet. Die Zahlungsverzögerung bzw. jede weitere Nichterfüllung berechtigt zur Einstellung der verbleibenden Lieferungen und zur Auflösung der laufenden Verträge; weiterhin berechtigt sie zur Inverzugsetzung des Käufers bei sofortigem Beginn der Laufzeit der Verzugszinsen. Unter Beibehaltung des Rechtes der Firma Tellure Rôta S.p.A., die Zahlung zu fordern, setzt, mit Vollberechtigung für die fälligen und nicht entrichteten Beträge, zu dem Fälligkeitsdatum folgenden Tag die Anrechnung der Verzugszinsen ein und zwar in Höhe von acht Prozent über dem gesetzlich festgelegten Diskontsatz, gemäß dem von der E.C.B. bestimmten Zinssatz, in Übereinstimmung mit dem D. Lgs 192/2012. Forderungen nach Zahlungsrückerstattungen oder Ausgleichszahlungen kraft eventueller Gegenansprüche seitens des Auftraggebers sind nicht zulässig.

8. Lieferfristen

Die vereinbarten oder bestätigten Versand- und/oder Lieferfristen werden in Werktagen angegeben und haben lediglich hinweisenden Charakter und sind deshalb rechtlich nicht verbindlich, ausgenommen davon ist die verbindliche Zusage seitens der Firma Tellure Rôta S.p.A., die aus der Auftragsbestätigung ausdrücklich hervorgehen muss und unter Vorbehalt des Auftretens von Fällen höherer Gewalt. Eventuelle Verzögerungen begründen deshalb in keinem Fall Schadenersatzansprüche oder die, auch teilweise, Auflösung des Vertrages; mit der Ausnahme, dass diese Folgen ausdrücklich von Firma Tellure Rôta S.p.A. in der Auftragsbestätigung angenommen wurden.

9. Versand und Transport

Soweit aus der Auftragsbestätigung keine abweichende Vereinbarungen hervorgeht, erfolgt der Verkauf ab Werk (ex Works). Teilversand seitens der Firma Tellure Rôta S.p.A. ist zulässig. Auch unter der Voraussetzung, dass die Firma Tellure Rôta S.p.A. den Betrag für den Versand der Ware bis zum vereinbarten Bestimmungsort entrichtet, gehen alle Risiken in Bezug auf den eventuellen Verlust oder die Beschädigung der Ware sowie in Bezug auf alle zusätzlich auftretenden Kosten für Vorfälle, die nach der Übergabe der Ware an der Frachtführer eintreten, von der Firma Tellure Rôta S.p.A. an der Käufer über und zwar zu dem Zeitpunkt, zu dem die Ware an den Frachtführer ausgehändigt wird. Eventuelle Vorbehalter, Beanstandungen und Klagen aus bzw. im Zusammenhang mit dem Versand und nachfolgenden Vorgängen müssen vom Käufer ausschließlich gegen den Frachtführer vorgebracht werden und zwar binnen einer verbindlichen Frist von 8 Tagen nach Erhalt der Ware, da die Fa. Tellure Rôta S.p.A. nicht für Vorfälle haftet, die nach Übergabe des Materials an eben diesen Frachtführer eintreten. Die Firma Tellure Rôta S.p.A. sorgt für die Verpackung in Übereinstimmung mit Erfahrung und

Gepflogenheit, wobei sie ausdrücklich von jeglicher Haftung für Verlust und/oder Beschädigungen befreit wird. Die Verwendung von spezifischem Verpackungsmaterial bzw. der Ausschluss der Verpackung im Falle von Waren, für die diese normalerweise verwendet wird, muss bereits bei Auftragserteilung zwischen der Firma Tellure Rôta S.p.A. und dem Käufer vereinbart werden. Soweit nicht vorgesehen und wenn und in dem mit dem vorliegenden Punkt vereinbarem Maße wird an dieser Stelle auf die Artikel 1678 und 1702 des C. C. (BGB des ital. Rechts, d. Üb.) verwiesen. Die Muster werden nur unter jeweils zusätzlicher Berechnung der gültigen Preise zur Verfügung gestellt.

10. Mängel und Fehler

Eventuelle Beanstandungen von Materialien, die sowohl in Bezug auf Menge als auch auf Qualität nicht den auftragsgemäßen Vereinbarungen entsprechen, müssen schriftlich binnen einer maximalen Frist von acht Tagen, zur Vermeidung des Ausschlusses, nach Eingang der Ware eingereicht werden. Sollte die Beanstandung fristgerecht eingehen und sich als begründet erweisen, ist die Verpflichtung der Firma Tellure Rôta S.p.A. zum Ersatz der als nicht entsprechend anerkannten Ware (auf jedem Fall immer im Lieferzustand) auf den Ort der Auslieferung der anfänglichen Lieferung begrenzt und zwar nach erfolgte Rückgabe derselben, unter Ausschluss des Rechtes seitens des Käufers auf Antrag auf Vertragsauflösung und direkten oder indirekten Schadenersatz sowie Ersatz aller eventuell ausgelegten Kosten. Die Firma Tellure Rôta S.p.A. akzeptiert und haftet nicht für Schäden an Dritten, wenn diese unter einer der nachfolgend aufgeführten Bedingungen auftreten: nicht sachgemäßer oder nicht korrekter Gebrauch, fehlerhafte Montage durch den Auftraggeber oder Dritte, natürlicher Verschleiß, nicht korrekte oder nachlässige Handhabung, elektrische oder chemische Auswirkungen, in dem Umfang, in dem diese nicht dem Verschulden durch Firma Tellure Rôta S.p.A. zugeschrieben werden können. Der Käufer verliert jedes Recht auf Beanstandung und somit auf Ersatz der Ware, wenn er nicht unverzüglich die Verwendung des den Gegenstand der Beanstandung bildenden Materials untersagt.

11. Rückgabe des Materials

Bei Irrtum des Käufers bei der Auftragserteilung kann das Material ausschließlich frei Empfänger und nach schriftlicher Genehmigung durch Firma Tellure Rôta S.p.A. nur dann zurückgegeben werden, wenn es sich in perfekt unversehrt und nicht benutztem Zustand befindet.

12. Änderungen an der Konstruktion

Die Firma Tellure Rôta S.p.A. kann an ihren Konstruktionen Änderungen jeder Art vor sich nehmen, ohne dass sie der Verpflichtung unterliegt, diese dem Käufer anzuzeigen. Änderungen, die nach erfolgter Bestellung vorgenommen werden, begründen keinen Anspruch auf Schadenersatz.

1. Datos generales

La relación contractual consecuencia de la formalización de cada uno de los pedidos está regulada por las siguientes condiciones generales de venta y por las condiciones específicas que se puedan incluir en el mismo pedido, donde se especifiquen por escrito. Los pedidos pasados a auxiliares e intermediarios de comercio son asumidos excepto por aprobación de Tellure Rôta S.p.A.

2. Oferta

Los documentos que forman parte de la oferta, como ilustraciones, diseños, indicaciones de peso y dimensiones, son determinantes sólo de manera aproximada si no se ha indicado expresamente que sean vinculantes. Tellure Rôta S.p.A. se reserva el derecho de propiedad y el derecho de autor relativos a presupuestos de gastos, diseños y otros documentos, que no deben ponerse a disposición de terceros. El comprador asume la plena responsabilidad por los documentos que él haya entregado a Tellure Rôta S.p.A. en caso de violación de los derechos de protección industrial de terceros, incluso en la relación con Tellure Rôta S.p.A. Ésta última puede poner a disposición de terceros los proyectos indicados por el comprador como confidenciales sólo con la aprobación del mismo.

3. Pedidos

Excepto si se acuerda diversamente por escrito, no se aceptan pedidos inferiores a los 500,00 Euros.

4. Variación del pedido confirmado

Tellure Rôta S.p.A. se reserva el derecho de rechazar o aceptar, incluso parcialmente, eventuales variaciones sucesivas del pedido o propuestas por el comprador. Si Tellure Rôta S.p.A. decide aceptar dichas variaciones, el nuevo precio, las modalidades de pago o las nuevas fechas de entrega serán fijadas por Tellure Rôta S.p.A. sin que varíen las otras condiciones.

5. Anulación del pedido confirmado

El comprador que anule un pedido confirmado, por cualquier motivo o razón, deberá pagar integralmente el importe relativo a los materiales y a los suministros ya efectuados por Tellure Rôta S.p.A. En cualquier caso, Tellure Rôta S.p.A. se reserva el derecho de solicitar una indemnización mínima igual al 25% de precio pactado con la facultad de retener este importe incluso de la suma que se haya recibido como pago anticipado del suministro.

6. Precios

Los precios se entienden como válidos para el material entregado franco fábrica Tellure Rôta S.p.A. excepto si se acuerda diversamente por escrito. Los precios del producto son los expuestos por Tellure Rôta S.p.A. en sus listas de precios en vigor o en sus ofertas; dichos precios, si no se han pactado todavía, podrán variarse en cualquier momento y serán aplicados inderogablemente en la fecha fijada por Tellure Rôta S.p.A.

7. Pagos

El pago de los suministros debe ser efectuado en el plazo pactado y según las condiciones especificadas en el pedido. Tellure Rôta S.p.A. está autorizada a emitir letras para cliente por las sumas y con los vencimientos indicados.

Los gastos relativos son a cargo del cliente. Todo envío se considera independiente de los otros a efecto de pago. El retraso en los pagos o cualquier otro incumplimiento otorgan a Tellure Rôta S.p.A. el derecho a la suspensión de los suministros restantes y a la resolución de los contratos en curso, además de dar lugar a que se soliciten al comprador, los intereses de demora, con efecto inmediato. En cuanto a las sumas vencidas y no pagadas, considerando el derecho de Tellure Rôta S.p.A. a exigir su pago, empezarán a contar, de pleno derecho, desde el día sucesivo al vencimiento debido, los intereses de demora con el incremento de ocho puntos, respecto a la tasa fijada por la B.C.E. de acuerdo al D.L. 192/2012. No se admiten solicitudes de reembolso de pagos o compensaciones debidas a cualquier pretensión, por parte del comitente.

8. Plazos de entrega

Los plazos de envío y/o entrega confirmados se expresan en días laborables y tiene sólo un valor indicativo y como tales no son jurídicamente vinculantes, excepto en caso de compromiso taxativo de Tellure Rôta S.p.A., que deberá figurar expresamente en la confirmación de pedido, y exceptuando los casos de fuerza mayor. Los posibles retrasos no darán lugar por lo tanto, en ningún caso, a indemnizaciones por daños o al cese, incluso parcial, del contrato, excepto si dichas consecuencias son expresamente aceptadas por Tellure Rôta S.p.A. en la confirmación de pedido.

9. Envío y transporte

Excepto si se pacta diversamente, lo cual debe figurar en la confirmación de pedido, la venta se produce franco fábrica (ex Works). Se admiten envíos parciales por parte de Tellure Rôta S.p.A. Incluso en caso de que Tellure Rôta S.p.A. pague el precio correspondiente al transporte de la mercancía hasta el lugar de destino pactado, el riesgo de pérdida o daño a la mercancía, así como cualquier otro gasto adicional debido a hechos sucedidos después de que la mercancía se haya entregado al transportista, pasa de Tellure Rôta S.p.A. al comprador en el momento en que la mercancía se entrega al transportista. Eventuales reservas, reclamaciones, acciones derivadas o bien relacionadas de cualquier manera con el transporte y las operaciones sucesivas, deberán ser realizadas por el comprador, y exclusivamente con respecto al transportista, en el plazo improrrogable de ocho días desde la recepción de la mercancía, no siendo Tellure Rôta S.p.A. responsable de todo aquello que sucede después de la entrega de los materiales al transportista. Tellure Rôta S.p.A. efectuará el embalaje

según su experiencia y usos quedando explícitamente eximida de cualquier responsabilidad por pérdida y/o averías.

El empleo de embalajes especiales, es decir, la exclusión del embalaje en el caso de mercancía para la cual normalmente éste se usa, deberá ser pactado entre Tellure Rôta S.p.A. y el comprador al efectuar el pedido. Para todo aquello no previsto y si son compatibles con este punto, debe remitirse a los artículos del 1678 al 1702 del código civil italiano. Tellure Rôta S.p.A. pone a disposición las muestras con la única condición de efectuar un adeudo suplementario en cada vez conforme a los relativos precios en vigor.

10. Vicios y defectos

Posibles reclamaciones por materiales que no correspondan, sea por su cantidad o por su calidad, con cuando indicado en el pedido, deben ser realizadas por escrito en el plazo máximo de ocho días desde la recepción de la mercancía so pena de vencimiento de plazo. Si la reclamación se hace rápidamente y tienen fundamento, la obligación de Tellure Rôta S.p.A. se limita a la sustitución de la mercancía reconocida como no correspondiente (considerando siempre el estado de suministro) en el mismo lugar de entrega que el suministro inicial, previa devolución de ésta, excluyendo todo tipo de derecho por parte del comprador a solicitar la resolución del contrato y la indemnización por daños directos o indirectos y la devolución de los gastos que haya podido sufragar por cualquier motivo. Tellure Rôta S.p.A. no aceptará reclamaciones y no responderá por daños causados a terceros si se ocasiona una sola de las siguientes condiciones: utilización inapropiada o no correcta, montaje defectuoso del comprador o de un tercero, desgaste natural, manipulación no correcta o negligente, efectos eléctricos o químicos, siempre en la medida en que no puedan considerarse culpa de Tellure Rôta S.p.A. El comprador pierde todo derecho de reclamación y por lo tanto de sustitución de la mercancía si no suspende el empleo de los materiales a los que se debe la reclamación.

11. Devoluciones de materiales

En caso de error del comprador en la fase de pedido, el material podrá ser devuelto exclusivamente en puerto franco, acompañado de la autorización escrita de Tellure Rôta S.p.A., sólo si está perfectamente integro y no ha sido utilizado.

12. Modificaciones en la fabricación

Tellure Rôta S.p.A. puede aportar cualquier tipo de modificación en sus fabricaciones sin obligación de notificarla al comprador. Las modificaciones aportadas después del pedido no darán lugar a ninguna clase de indemnización.

1. Общие правила

Контрактные отношения, направленные на совершенствование каждого отдельного заказа, регламентируются данными условиями продажи и возможными дополнительными условиями, указанными в самом заказе и скрепленными соответствующими подписями. Заказы, переданные вспомогательным структурам или торговым посредникам, принимаются после утверждения со стороны Tellure Rôta S.p.A.

2. Коммерческое предложение

Документы, составляющие коммерческое предложение, такие как иллюстрации, чертежи, указания веса и размеров, являются определяющими в общем плане, если они специально не оговорены как обязательные. Фирма Tellure Rôta S.p.A. оставляет за собой право собственности и авторские права на предварительные сметы, чертежи и другие документы, которые не должны передаваться третьим лицам. Заказчик берет на себя полную ответственность за документы, переданные им фирме Tellure Rôta S.p.A., в случае нарушения прав промышленной защиты третьих лиц, включая отношения с фирмой Tellure Rôta S.p.A. Последняя обязана предоставить доступ третьих лиц к проектам, которые заказчик обозначил как конфиденциальные, исключительно с одобрения самого заказчика.

3. Заказы

При отсутствии иной письменной договоренности заказы, стоимостью ниже 500,00 Евро, будут исполняться с начислением дополнительных 15,00 Евро за счет клиента.

4. Изменение подтвержденного заказа

Фирма Tellure Rôta S.p.A. оставляет за собой право отказать или принять, в том числе даже частично, возможные последующие изменения заказа и предложения покупателя. В случае принятия таких изменений новая цена, условия оплаты или новые даты поставки будут определены фирмой Tellure Rôta S.p.A. при сохранении неизменными всех остальных условий.

5. Аннулирование подтвержденного заказа

Заказчик, аннулирующий по любым причинам соображениям подтвержденный заказ, обязан полностью оплатить стоимость материалов и поставок, уже заказанных фирмой Tellure Rôta S.p.A. Фирма Tellure Rôta S.p.A. в любом случае имеет право на минимальное возмещение, равное 25% от договоренной цены с правом удержать эту сумму из средств, полученных в качестве предоплаты поставки.

6. Цены

Цены следует понимать за материал франко-фабрика Tellure Rôta S.p.A., при отсутствии других письменных договоренностей. Цены на продукцию указаны фирмой Tellure Rôta S.p.A. в действующих ценовых листах или в коммерческих предложениях; однако, эти цены, если они еще не согласованы, могут быть изменены в любой момент и будут действовать в обязательном порядке

начиная с даты, установленной фирмой Tellure Rôta S.p.A.

7. Условия оплаты

Оплата поставок должна выполняться в пределах договоренных сроков и по условиям, согласованным в заказе. В любом случае фирма Tellure Rôta S.p.A. имеет право выставлять тратты клиенту на сумму к оплате в пределах установленных сроков. Связанные с этим расходы будут за счет клиента. Каждая отправка продукции считается независимой от остальных в плане оплаты. Задержка оплаты или любое другое неисполнение согласованных условий дают право на приостановку оставшихся поставок на расторжение действующего контракта, а также на немедленное начисление процентов за просрочку платежей со стороны покупателя. На просроченные и неоплаченные суммы, при сохранении права фирмы Tellure Rôta S.p.A. требовать оплаты, по закону будут начисляться, начиная со следующего дня от установленной даты оплаты, проценты в размере законной ставки процентов, увеличенной на 7 пунктов в соответствии с Постановлением № 231 от 09 октября 2002 года, введенного в действие Указом Европейского Парламента и Совета № 2000/35/CE от 29 июня 2000 года. Непринимаются требования о возмещении, оплате или компенсации в случае любых возможных встречных претензий со стороны заказчика.

8. Сроки поставки согласованные и

утвержденные сроки отправки и/или поставки выражаются в рабочих днях и имеют ориентировочный характер и в этом смысле не являются юридически обязательными, за исключением случая неукоснительного обязательства со стороны Tellure Rôta, которое должно быть письменно выражено в подтверждении заказа при исключении формальных обстоятельств. Возможные задержки не могут никаким образом привести к возмещению ущерба или расторжению, даже частичному, контракта, если такие последствия не приняты в письменном виде фирмой Tellure Rôta S.p.A. при подтверждении заказа.

9. Отправка и транспорт

При отсутствии иных договоренностей, которые должны быть указаны в подтвержденном заказе, продажа производится на условиях франко-фабрика (Ex-works). Допускаются частичные отправки со стороны Tellure Rôta. Даже если допускаются случаи, когда фирма Tellure Rôta производит оплату транспортировки товара до согласованного места назначения, риск потери или повреждения товара, как и любые другие дополнительные расходы, наступившие после передачи товара перевозчику, переходят от фирмы Tellure Rôta к покупателю в момент передачи товара перевозчику. Возможные претензии, повреждения или действия, вызванные и как-либо связанные с транспортировкой и последующими операциями, должны быть предъявлены покупателем и исключительно в отношении перевозчика, в срок не позднее восьми дней

после получения товара, при этом фирма Tellure Rôta не несет никакой ответственности за все, что могло случиться после передачи товара перевозчику. Фирма Tellure Rôta обеспечит упаковку согласно опыту и правилам, при этом однозначно освобождается от любой ответственности за потери и/или повреждения. Применение особых типов упаковки или исключение определенной упаковки, которую обычно используют для данного товара, должно быть согласовано между фирмой Tellure Rôta и покупателем в момент оформления заказа. Все, что здесь не предусмотрено и несовместимо с данным пунктом, регулируется на основании здесь названных статей от 1678 до 1702 Гражданского Кодекса. Образцы предоставляются фирмой Tellure Rôta только при условии их дополнительной оплаты в каждом конкретном случае по соответствующим действующим ценам.

10. Брак и дефекты

Возможные претензии к продукции, как в отношении качества так и количества, несоответствующих указанному в заказе, должны быть предъявлены в письменном виде в срок не позднее восьми дней со дня получения товара, иначе это право утрачивается. В случае если претензия поступает вовремя и является обоснованной, обязательство фирмы Tellure Rôta S.p.A. заключается в замене товара, признанного несоответствующим (в любом случае на стадии поставки), с доставкой до места первоначальной поставки товара после того, как бракованный продукт будет возвращен фирме, при этом исключается право покупателя требовать расторжения контракта и возмещения прямого или непрямого ущерба, а также возмещения любых понесенных расходов. Фирма Tellure Rôta S.p.A. не примет претензии и не будет отвечать за причиненный ущерб третьим лицам при выявлении хотя бы одного из следующих условий: неправильное или не по назначению применение; плохой монтаж, выполненный заказчиком или третьим лицом; естественный износ; неправильные или небрежные манипуляции; электрические или химические последствия в пределах, которые не могут вменяться в вину Tellure Rôta S.p.A. Покупатель теряет право на рекламацию и соответственно на замену товара, если немедленно не прерывает использование материалов, предмета рекламации.

11. Возврат материалов







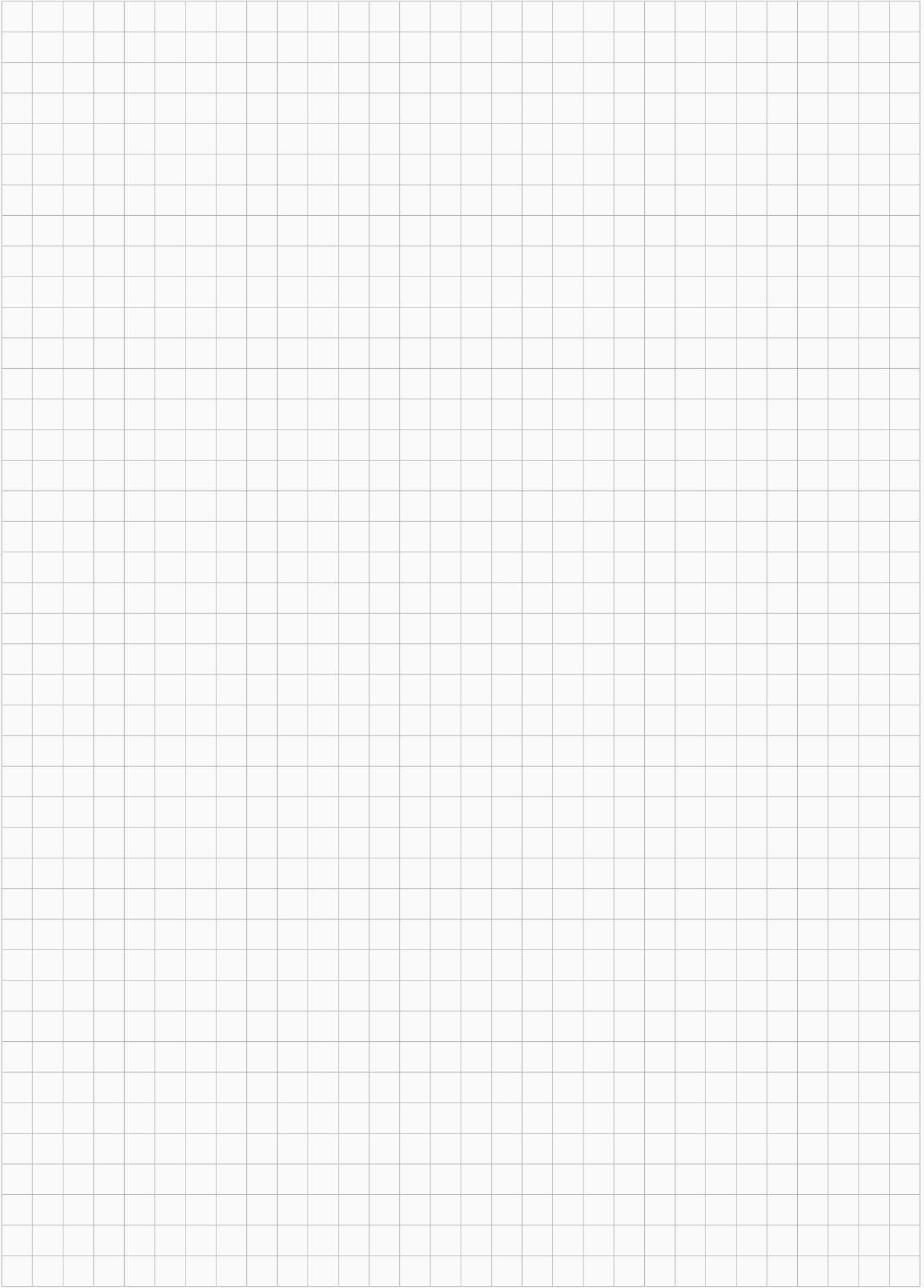















В случае ошибки покупателя на стадии заказа, материал может быть возвращен исключительно на условиях оплаченной перевозки по письменному разрешению Tellure Rôta S.p.A., при условии его полной целостности и неиспользованности.

12. Модификации в конструкции

Фирма Tellure Rôta S.p.A. может привносить любые модификации в свои конструкции без обязательства извещать об этом покупателя. Модификации, внесенные после выполнения заказа, не могут быть причиной какого-либо возмещения.



Legenda / Symboles / Zeichenerklärung / Leyenda / Условные Обозначения

	<p>Diametro ruota Wheel diameter Diamètre roue Raddurchmesser Diametro ruoda Диаметр колеса</p>		<p>Supp. rot. foro fissaggio, freno ant. Bolt hole swivel castor with front lock Roul. pivot. à oeil, blocage avant Lenkr. Rückenloch, Festst. im Nachl. Sop.gir. taladro pasador, freno ant. Пов. кроншт. со сквозным отверстием, передним тормозом</p>		<p>Parafili Threadguards Para-fils Fadenschutz Placa anti-hilos Устройство, предохраняющее от попадания нитей</p>
	<p>Portata daN a 4 km/h Load capacity daN Capacité de charge daN Tragkraft daN Capacidad de carga daN Грузоподъемность daN 4 km/h</p>		<p>Supporto rotante con codolo Swivel castor with stem Roulette pivotante avec tige Lenkrolle mit Zapfen Soporte giratorio com espiga Поворотный кронштейн с хвостовиком</p>		<p>Contropiastre Counterplates Contre-platines Gegenplatten Contra-placas Панели кронштейнов</p>
	<p>Carico statico daN Static load daN Charge statique daN Statische Last daN Carga estática daN Статическая нагрузка daN Static</p>		<p>Supp. rotante codolo freno ant. Swivel castor with stem, front lock Roulette piv. av. tige, bl. avant Len. mit Zapfen, Festst. im Nachlauf Sop. girat. espiga, freno ant. Поворотный кронштейн с хвостовиком с передним тормозом</p>		<p>Codolo liscio, dado Stem, nut Tige lisse, écrou Glatzapfen, Mutter Espiga, tuerca Гладкий хвостовик, гайка</p>
	<p>Supporto rotante a piastra Swivel castor with top-plate Roulette pivotante à platine Lenkrolle mit Platte Soporte giratorio con platina Поворотный кронштейн с панелью</p>		<p>Mozzo con foro a boccola Hub with plain bearing Moyeu lisse Nabe mit Gleitlager Buje liso Ступица с втулкой</p>		<p>Codolo filettato, rondella, dado Threaded stem, washer, nut Tige filetée, rondelle, écrou Gewindezapfen, Scheibe, Mutter Espiga roscada, arandela, tuerca Резьбовой хвостовик, шайба, гайка</p>
	<p>Supporto fisso Fixed castor Roulette fixe Bockrolle Soporte fijo Фиксированный кронштейн</p>		<p>Mozzo con cuscinetto a rulli Hub with roller bearing Moyeu avec roulem. à rouleaux Nabe mit Rollenlager Buje con cojinete a rodillos Ступица с роликовым подшипником</p>		<p>Quantità confezioni standard Quantity for standard packing Quantité emballage standard Menge für Standard-Verpackung Cantidad embalaje standard Количество в стандартных расфасовках</p>
	<p>Supporto rotante, freno anteriore Swivel castor with front lock Roulette pivotante à blocage avant Lenkrolle mit Festseller im Nauchlauf Soporte giratorio, freno delantero Поворотный кронштейн с передним тормозом</p>		<p>Mozzo con cuscinetto a rulli inox Hub with s.s. steel roller bearing Moyeu avec roulem. à roul. inox Nabe mit rostfreiem Rollenlager Buje con cojinete a rodillos inox Ступица с роликовым подшипником из нерж. стали</p>		<p>Qtà min. imballo industriale Min. qty for industrial packaging Qté min. emballage industriels Mind. Menge Industrieverpackung Cantidad mín. embalaje indust. Минимальное количество в промышленной упаковке</p>
	<p>Supporto rotante, freno posteriore Swivel castor with back lock Roulette piv. à blocage derrière Lenkrolle mit Festseller im Vorlauf Soporte giratorio, freno anterior Поворотный крон. с задним тормозом</p>		<p>Mozzo con cuscinetto a sfera Hub with ball bearing Moyeu avec roulement à billes Nabe mit Kugellager Buje con cojinete a bolas Ступица с шариковым подшипником</p>	COD. 659301	<p>Articoli in Gamma Base Essential Range items Références en Gamme Base Grundsortiment-Artikeln Articulos en Gama Base Изделия, представленные в базовой гамме</p>
	<p>Supporto rotante freno centralizzato Swivel castor, central brake system Roulette piv. à freinage centralisé Lenkrolle mit Zentralfeststeller Soporte girat. freno centralizado централизованной блокировкой</p>		<p>Mozzo con sede cuscinetto Hub with ball bearing facilities Logement pour roulements Nabe mit Lagersitz Alojam. para cojinetes a bolas Ступица без подшипника</p>		<p>Pagina catalogo 01/2021 Page catalogue 01/2021 Page catalogue 01/2021 Seite im Katalog 01/2021 Página catálogo 01/2019 Страницы каталога 01/2021</p>
	<p>Supporto rotante, foro di fissaggio Swivel castor with bolt hole Roulette pivotante à oeil Lenkrolle mit Rückenloch Soporte giratorio, taladro pasador Пов. кроншт. сквозным отверстием</p>		<p>Mozzo con cuscinetto a sfera inox Hub with stainless steel ball bearing Moyeu avec roulement à billes inox Nabe mit Edelstahl-Kugellager Buje con cojinete a bolas inox Ступица с шариковым подшипником из нерж. стали</p>		<p>Pagina listino 02/21 Page price list 02/21 Page tarif 02/21 Seite im Preisliste 02/21 Página tarifa 02/21 Страницы прейскуранта 02/21</p>



SEE WEBSITE



Tellure Rôta

Via Quattro Passi 15 - 41043 Formigine (MO)
Tel. Italia 059 410300-306 - Tel. Export 0039 059 410231-253
Fax 0039 059 572859
comm.italia@tellurerota.com
comm.estero@tellurerota.com
www.tellurerota.com



TR Lab

Via Aldo Moro, 14/G-H - 41043 Formigine (MO)
Tel. 0039 059 410271
Fax 0039 059 573167
info@trlab.it
www.trlab.it



UNI EN ISO 9001-2015



UNI EN ISO 14001-2015



UNI EN ISO 45001-2018